

ESB101

Inrush Current Limiter, Inrush Current Protection

For capacitive loads, 115Vac/230Vac 16A, 16 ⅓ Hz – 440Hz, - 40°C ... +60°C

Short Specification:

- Peak- / R.M.S. inrush current limiter
- 90-132Vac / 184-264Vac, 16A continuous
- Power consumption 1,1W @ 230Vac
- DIN TS35mm DIN-Rail
- Wall mount (universal case)
- Spring-type terminals 6mm² / 10AWG
- Integrated bypass relay
- Capacitive load 1.500uF up to 10.000uF
- Integrated thermal protection
- IP20 UL94V-0 case DIN43880 for DIN/VDE0603 cutout box
- EN62368-1, EN55032 class B

The ESB is a budget-priced inrush peak current limiter for high loads in LED-applications, complex automation systems and in the machine building. The ESB101 offers effective and interference free operation with capacitive loads. It is simple to integrate into existing equipment. The ESB101 is self-powering and does not require an external power supply.

16 ⅓ Hz – 440Hz

No simple NTC-solution! It allows to reduce cabling sections and to install fast circuit breakers. 100% protection from tripping pre-installed circuit breakers or burning relay and line switch contacts.



Technical Table								
Model	ESB101.05UPS	ESB101.16	ESB101.23	ESB101.23S	ESB101.33	ESB101.LED.230VAC	ESB101.LED.115VAC	ESB101.23S.115VAC
Peak Current Limiting $\pm 6\%$	5A	16A	23A	23A	33A	48A	43A	23A
R.M.S Current Limiting $\pm 6\%$	3,5A	11,3A	16,3A	16,3A	23,3A	33,9A	30,4A	16,3A
Maximum Allowed Capacitive Load	1.000uF	1.500 μ F	2.000uF	2.000uF	4.000 μ F	6.000uF	10.000uF	4.000 μ F
Limiting Time (T _{on} Power On)	900ms (± 50 ms)	300ms (± 50 ms)	300ms (± 50 ms)	500ms (± 50 ms)	300ms (± 50 ms)	300ms (± 50 ms)	300ms (± 50 ms)	500ms (± 60 ms)
Release Time (T _{off} Low Voltage)	1400ms (± 50 ms)	500ms (± 50 ms)	500ms (± 50 ms)	800ms (± 80 ms)	500ms (± 50 ms)	550ms (± 50 ms)	550ms (± 50 ms)	900ms (± 80 ms)
Limiting Interval [T _{interval} for AC _{cont.}]	≥ 900 ms	≥ 900 ms	≥ 900 ms	≥ 1400 ms	≥ 900 ms	≥ 900 ms	≥ 900 ms	≥ 1400 ms
Quickest advisable Circuit breaker at 30°C	A2A	A6A B4A Z6A	A10A B6A Z10A	A10A B6A Z10A	A13A B8A Z13A	B13A	A16A B13A Z16A	A10A B6A Z10A
AC Input Range	184-264Vac						90-132Vac	
AC Continuous Input Range	230Vac						115Vac	
Line Frequency	16 2/3 Hz – 440Hz						16 2/3 Hz – 440Hz	
Switch-On Voltage	144Vac						79Vac	
AC Lower Margin	52Vac (AC dump / drop out voltage)						28Vac (AC dump / drop out voltage)	
AC Current	16A continuous load current							
Power Supply	No external power supply required, item is self-powering							
Power consumption	2,2W @ 115Vac / 1,1W @ 230Vac							
Limiting Cycles	Between each limiting action shall be a break of 20 sec., to let the device cool down until the next limiting starts							
Internal Protection	Thermal fuse protects from overheat & fire							
Cooling	Natural convection							
Operation Temp.	Ambient temperature -40°C ... +60°C continuous (see operations temperature list for details in this manual)							
Storage Temp.	-40°C ... +85°C for 2 years							
EMI	EN55032 class B, EN61000-6-3							
EMS	EN61000-6-2							
Safety Norms	EN61010-1, EN61010-2-201, EN62368-1, EN60950-1, several units: ANSI/UL508 & CAN/CSA C22.2 (see product list in this manual), UL-File: E485106							
Safety Class	Class II							
ROHS conformity	ROHS Directive 2011/65/EU							
REACH conformity	REACH Directive 1907/2006							
MTBF Calculation	300.000h (IEC/EN61709, Siemens SN29500)							
MTTF Calculation	384.000h (+30°C) (IEC/EN61709, Siemens SN29500)							
Humidity	95% (+25°C) not condensing							
Pollution Degree	2 (IEC/EN50178)							
Environmental	Thermal environment 3K3, mechanics 3M4 (IEC/EN60721)							
Altitude max.	4000m (13123 ft.) above sea level							
Dimensions (WxHxD)	(Wide=2TE), 36,5x110x62mm							
Housing Parameters	UL94V-0 (E45329), ABS/NH6020, RTI 110°C, housing for DIN/VDE0603 cutout box and for wall mount							
DIN-Rail	DIN-Rail TS35mm DIN/EN60715 (TS35/7,5 und TS35/15)							
Weight	0,12kg / 0,26lbs							
Connections	Spring-type terminal solid max. 0,18...6mm ² 26...10AWG according with IEC/EN60664-1, IEC/EN61984 Use copper conductors only. Wire stripping length 7mm. Tightening torque per terminal block is 0.5 - 0.6 Nm / 4.5 - 5.3 lbf-in							

General Description

The ESB101-series are the 2nd generation and cost-effective inrush current limiters. The limiters are made for 115/230Vac 16A networks. The line frequency range is 16½Hz – 440Hz. The ESB101-Limiter shall be located between the line-switcher/contactor and the load (Fig.1). The ESB-models are designed for capacitive loads (not for inductive loads like coils/transformers, not for AC-motors and not for DC-voltage application). In the moment of switching-on the system the inrush current of the installed load will be limited for the defined time T_{on} (Fig.4). Independent from the previous inrush level; the current limiting is always strict. After T_{on} elapses the current limiting circuit of the ESB101 will be bypassed. Then the load is directly connected to the AC. If an AC dump overshoots the defined time T_{off} , it will be detected by the ESB101 (Fig.5). As soon as the AC recovers the inrush will be limited, again (Fig.2 & 3). The ESB101-models provide an internal temperature control. In case of a failure the device shuts down to safely prevent from overheating or fire.

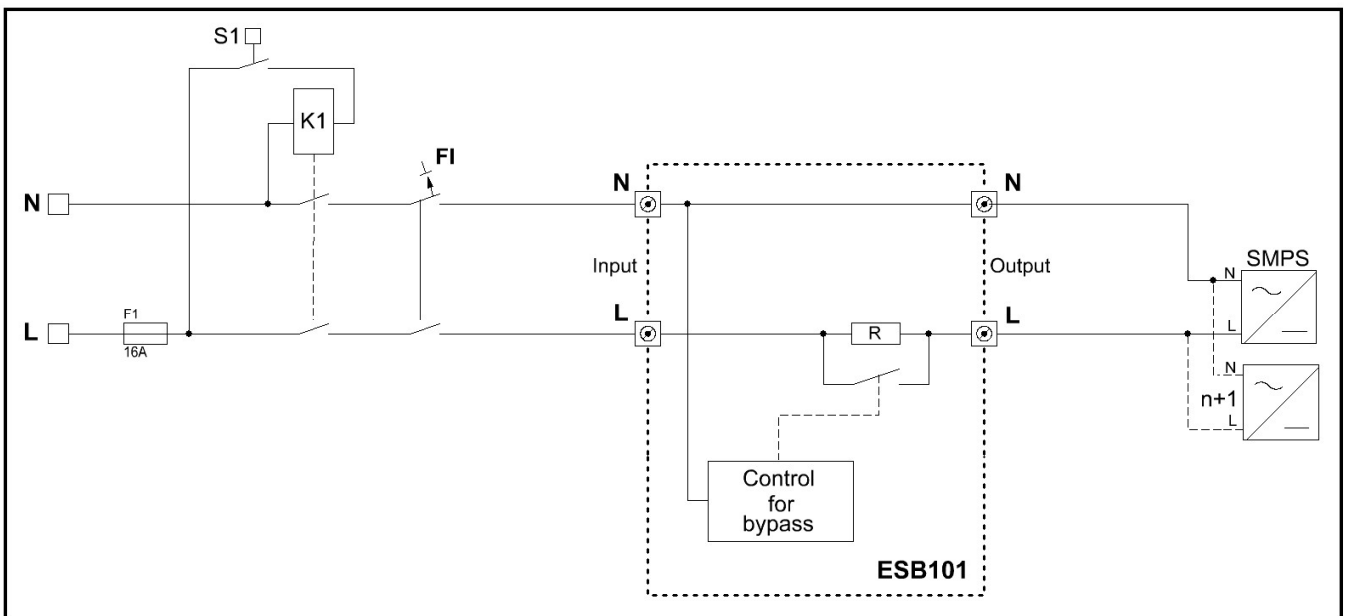

(Fig.1)

Field Applications

The ESB101 limiter allows connecting much more capacitive loads (e.g. LED-power supply / LED-driver) to a pre-installed circuit breaker CB (Fig.1). The ESB avoids that the MCB will be tripped. This occurs independent to the objective initial current. The result is that the number of A.C. branch lines and the pre-installed MCB can be reduced dramatically. Installation cost exhibit a sustained decline. Alternatively, the cross section of the branch lines can be reduced when using smaller and faster responding circuit breakers. The cost saving from copper is essential. Sensitive AC networks can be fused safer (e.g. Traffic Control Systems, Street-Lighting, Parking Lots and Tunnels). When the ESB101 is installed correctly, the neutral wire (N) is looped trough (Fig.1). The inrush protection circuit always acts to the line conductor. The load relates to the AC in such a way that a circuit breaker or an earth-leakage-trip works within the limits of the legal rules. This fact is also applied while the limiting circuit acts. The ESB101 is designed for capacitive loads, only. The ESB101 cannot be used together with transformers, coils, AC-motors & drives, heaters, ohmic load, or with DC-voltage at all.

Special Models ESB101.LED with 115Vac & 230Vac

Compared to all other ESB101-models the LED-types are the universal inrush current limiters. The concept design is made to construct optimized A.C. networks in the building automation and in the lighting sector. Tripping the installed circuit breaker will be effectively prevented. The inrush limiting time is adjusted to the values of a typical LED switch mode power supply or LED-driver. The connectable load capacity is such as high, that even in the extremes cases it is rather impossible to exceed it in a 16A network. Installed contactors will be relieved and their lifetimes will considerable increase. To protect the installed relay in a controlled DALI-/DMX-Multiplexer we advise to use the ESB101.23 for a 16A relay or the ESB101.16 for a smaller relay. Note that the ESB101 is not designed to operate together with gas induction lamps or other conventional lighting device. The ESB101 is designed for capacitive loads, only.

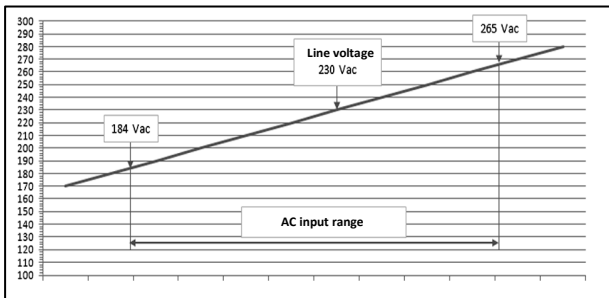

(Fig.2 operating range 230Vac)

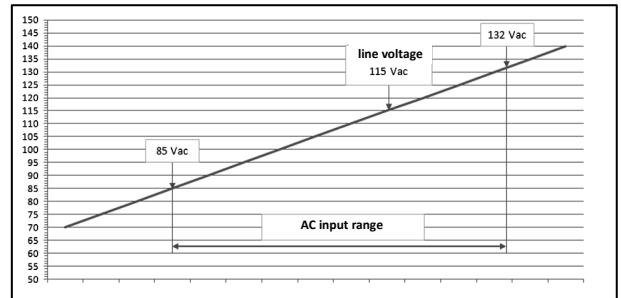

(Fig.3 operating range 115Vac)

Design-In of the ESB101 into A/C networks

The ESB101 models are the precise inrush current limiter with an overall tolerance of $\pm 6\%$ of the face value. For the dimension of an upstream connected circuit breaker the R.M.S is the key value of the inrush current, not the peak current. The thermal trigger point will not be met, even while using an extreme fast CB. All-dominant is the magnetic trigger current. By using the empirical formula $I_{(peak)} \times 0,707_{(factor)} = I_{(r.m.s.)}$ the tripping current can be defined exact. Bear in mind that all the higher the inrush current is, all the faster the input capacitor of several connected switch mode power supplies will be loaded. Deduced by this fact we can say that within a 230V 16A A/C network not the ESB101.16 limiter is the right selection for a MCB B16A, but the ESB101.LED.230VAC. The technical table on page 2 shows the R.M.S value of all the ESB101 types and models.

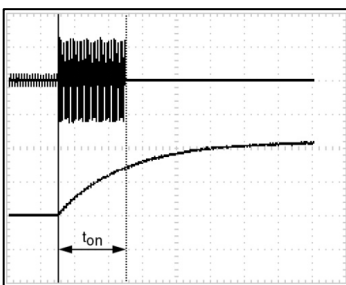

(Fig.4 limiting time T_{on})

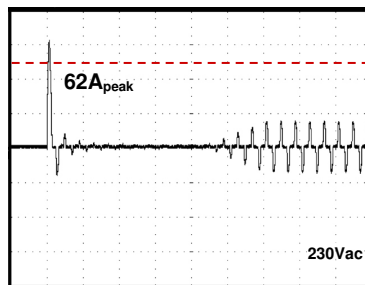

(Fig.5 AC dump detection T_{off})

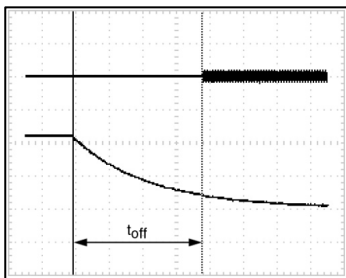

(Fig.6 AC dump detection T_{off})

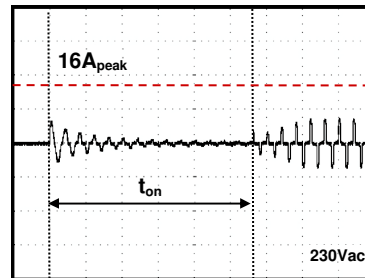

(Fig.7 inrush with ESB101)

Fig.5 and Fig.7

Fig.5 and Fig.7 show the typical start behavior of a NTC protected sample switch mode power supply. The used test item is a switch mode power supply on DIN-Rail.

The peak current recordings show the precise limiting of the inrush from formerly $62A_{peak}$ to $16A_{peak}$. The corresponding R.M.S level, that is responsible for the magnetic tripping of the circuit breaker (MCB), is mark down by factor 0,707. After the time T_{on} elapsed it is identified that the power supply starts neatly into the continuous operation mode. Now the current is absorbed pulse-shaped from the AC supply. In detail the full load R.M.S. current consumption level of the sample power supply hits $9,8A @ 230Vac$.

Mechanics

IP20 housing, UL94V-0 (E45329), ABS/NH6020 with RTI 110°C, housing for DIN/VDE0603 cutout box and wall mount. DIN 43880 with IEC standardized ventilation slots. Save fix on DIN-Rail TS35mm (7.5/15) DIN/EN60715. It is designed for building cabinets DIN/VDE0603. Easy to wall mount by multifunctional housing; remove the DIN-Rail latch and access the two mounting holes to screw the ESB101 to any old surface.

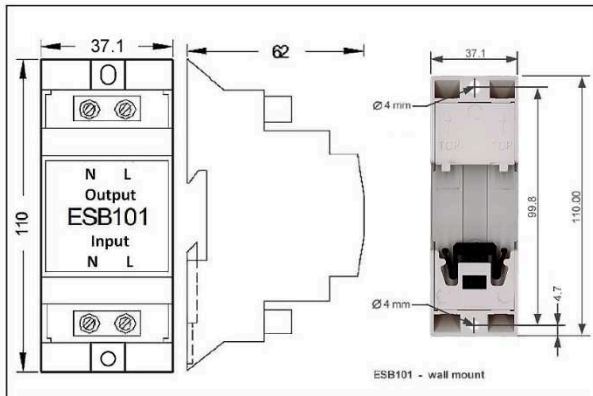

(Fig.8 mechanical drawing)

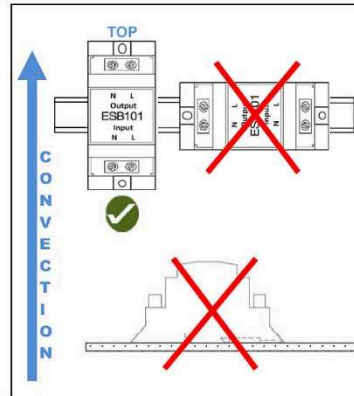

(Fig.9 mounting restriction)

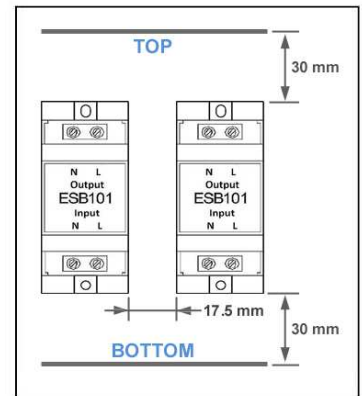

(Fig.10 mounting distances)

Connections

Clamping Yoke Connector Specifications

	Input / Output connections
Tightening torque min. – max.	0,5 – 0,6Nm (blade 1,0x5,5 DIN5264)
Touch-safe protection acc. to DIN VDE 0470	IP20 plugged/ IP10 unplugged
Clamping range, min. – max.	0,18 – 6mm ² / AWG26 – AWG10
Solid, H05(07) V-U min. – max.	0,18 – 6mm ²
Stranded, H05(07) V-U min. – max.	0,22 – 4 mm ²
w. plastic collar ferrule, DIN 46228 pt 4 min. – max.	0,5 – 2,5mm ²
w. wire end ferrule, DIN 46228 pt 1, min. – max.	0,5 – 4mm ²
Plug gauge in accordance with EN 60999 a x b; ø	3,6 x 3,1mm; 2,7mm
Pitch (P)	9,52mm

Wire Stripping Length (fine wired)

Nominal Cross Section	Wire End Ferrule	Stripping Length
0,5mm ²	H0,5/6	6mm
0,75mm ²	H0,75/6	6mm
1,0mm ²	H1,0/6	6mm
2,5mm ²	H2,5/7	7mm
4,0mm ²	H4,0/7	7mm

The length of ferrules is to be chosen depending on the rated voltage. The outside diameter of the plastic collar should not be larger than the pitch (P)

Mounting Instructions

Follow the above mounting restrictions to allow maximum lifetime of the product and to prevent from tripping the internal temperature protection fuse. The ESB101 is an active device. The distance between an ESB101 and the next active or temperature sensitive device shall be 17,5mm or larger. The power consumption of the device is constant at continuous operation (2,2W @ 115Vac / 1,1W @ 230Vac). Make sure that the ventilation holes below and above the unit are not blocked to allow free air convection.

Operation Temperature	Ambient Temperature	ESB101, 115Vac, AC 16A current	ANSI / UL 508	-40°C ... +55°C
			CAN / CSA C22.2	-40°C ... +55°C
			IEC EN62368-1 / IEC EN60950-1	-40°C ... +60°C
		ESB101, 230Vac, AC 10A current	ANSI / UL 508	-40°C ... +55°C
			CAN / CSA C22.2	-40°C ... +55°C
			IEC EN62368-1 / IEC EN60950-1	-40°C ... +60°C
		ESB101, 230Vac, AC 16A current	ANSI / UL 508	-40°C ... +50°C
			CAN / CSA C22.2	-40°C ... +50°C
			IEC EN62368-1 / IEC EN60950-1	-40°C ... +55°C

Table of the standards

Product Code	Camtec Article No.	IEC / EN 62368-1 IEC / EN 60950-1	ANSI / UL508 listed UL-File E485106	CAN / CSA 22.2 listed UL-File E485106	GHOST EAC #0658490 RU C-DE.MO10.B.02970
ESB101.16(R2)	3041081001CA	Yes	Yes	Yes	Yes
ESB101.23S(R2)	3041081002CA	Yes	Yes	Yes	Yes
ESB101.23(R2)	3041081003CA	Yes	Yes	Yes	Yes
ESB101.33(R2)	3041081004CA	Yes	Yes	Yes	Yes
ESB101.LED.230VAC(R2)	3041081005CA	Yes	Yes	Yes	Yes
ESB101.LED.115VAC(R2)	3041081006CA	Yes	Yes	Yes	Yes
ESB101.23S.115VAC(R2)	3041081007CA	Yes	Yes	Yes	Yes
ESB101.05UPS(R2)	3041081009CA	Yes	Not listed	Not listed	Yes

Safety regulations: Please read these instructions completely before using the equipment. Keep these instructions on to hand. The device may only be installed by trained specialist staff.

Installation:

- 1) The device is designed for devices and systems that meet the standard requirements for hazardous voltages, power, and fire prevention.
- 2.) Installation and service only by trained persons. The AC power must be switched off. The work is to be labelled; accidental reconnection of the system must be prevented.
- 3.) Opening the device, its modification, loosening bolts, or operation outside the specified herein specification or in an unsuitable environment, has the immediate loss of warranty to follow. We disclaim any responsibility for any resulting damage to persons or things.
- 4.) Note: The device must not be operated without an upstream circuit breaker (CB). The CB must not be larger than 16A.

Warning:

Non-compliance these warnings can result in fire and serious injury or death.

1. Before connecting the device to the AC network, make wires free of voltage and assure accidentally switch on.
2. Allow neat and professional cabling.
3. Never open nor try to repair the unit. Inside are dangerous voltages that can cause electrical shock hazard.
4. Avoid metal pieces or other conductive material to fall into the item
5. Do not operate the device in damp or wet conditions
6. Do not operate the unit under EX-conditions
7. Do not operate the unit with then capacitive load



English Installation instruction	<p>Read this first! Before operating this device, please read this manual thoroughly and retain this manual for future reference! This device may only be installed and put into operation by qualified personnel. If damage or malfunction should occur during operation, immediately turn power off and send device to the factory for inspection. The device does not contain serviceable parts. The information presented in this document is believed to be accurate and reliable and may change without notice. For any clarifications, the English translation will be used.</p> <p>WARNING Risk of electrical shock, fire, personal injury, or death:</p> <ul style="list-style-type: none"> - Turn power off before working on the device. Protect against inadvertent re-powering. - Do not open, modify, or repair the device. - Use caution to prevent any foreign objects from entering the housing. - Do not use in wet locations or in areas where moisture or condensation can be expected. - Do not touch during power-on and immediately after power-off. Hot surfaces may cause burns.
Deutsch Installations- anweisung	<p>Vor der Inbetriebnahme lesen! Bitte lesen Sie diese Warnungen und Hinweise sorgfältig durch, bevor Sie das Gerät in Betrieb nehmen. Bewahren Sie die Anleitung zum Nachlesen auf. Das Gerät darf nur durch fachkundiges und qualifiziertes Personal installiert werden. Bei Funktionsstörungen oder Beschädigungen schalten Sie sofort die Versorgungsspannung ab und senden das Gerät zur Überprüfung ins Werk. Das Gerät beinhaltet keine Servicebauteile. Die angegebenen Daten dienen allein der Produktbeschreibung und sind nicht als zugesicherte Eigenschaften im Rechtsinne aufzufassen. Im Zweifelsfall gilt der englische Text.</p> <p>WARNUNG Missachtung nachfolgender Punkte kann einen elektrischen Schlag, Brände, schwere Unfälle oder Tod zur Folge haben:</p> <ul style="list-style-type: none"> - Schalten Sie die Eingangsspannung vor Installations-, Wartungs- oder Änderungsarbeiten ab und sichern Sie diese gegen unbeabsichtigtes Wiedereinschalten. - Führen Sie keine Änderungen oder Reparaturversuche am Gerät durch. Gerät nicht öffnen! - Verhindern Sie das Eindringen von Fremdkörpern, wie z.B. Büroklammern und Metallteilen. - Betreiben Sie das Gerät nicht in feuchter Umgebung oder in einer Umgebung, bei der mit Betauung oder Kondensation zu rechnen ist. - Gehäuse nicht während des Betriebes oder kurz nach dem Abschalten berühren. Heiße Oberflächen können Verletzungen verursachen.
Français Instruction d'installation	<p>A lire avant mise sous tension! Veuillez lire ces instructions de montage et d'entretien avant de mettre l'alimentation sous tension. Conservez ce manuel qui vous sera toujours utile. Cette alimentation ne doit être installée que par du personnel qualifié et compétent. En cas de dommage ou dysfonctionnement, coupez immédiatement la tension d'alimentation et retournez l'appareil à l'usine pour vérification! L'alimentation ne contient pas de pièces échangeables Les données indiquées dans ce document servent uniquement à donner une description du produit et n'ont aucune valeur juridique. En cas de divergences, le texte anglais fait foi.</p> <p>AVERTISSEMENT Prendre en compte les points suivants, afin d'éviter toute détérioration électrique, incendie, dommage aux personnes ou mort:</p> <ul style="list-style-type: none"> - Mettre l'alimentation hors tension avant toute intervention sur celle-ci et s'assurer qu'il n'y a pas risque de redémarrage. - Ne pas ouvrir, modifier ou réparer l'alimentation. - Veiller à ce qu'aucun objet ne rentre en contact avec l'intérieur de l'alimentation (trombones, pièces métalliques). - Ne pas faire fonctionner l'appareil dans un environnement humide ou dans un environnement où il peut y avoir de la condensation. - Ne pas toucher le carter pendant le fonctionnement ou directement après la mise hors tension. Surface chaude risquant d'entraîner des blessures.
Español Instrucciones de instalación	<p>Lea primero! Conserve este manual como referencia para futuras consultas. La fuente de alimentación solo puede ser instalada y puesta en funcionamiento por personal cualificado. Por favor lea detenidamente este manual antes de conectar la fuente de alimentación. Si se produce un fallo o mal funcionamiento durante la operación, desconecte inmediatamente la tensión de alimentación. En ambos casos, el equipo debe ser inspeccionado en fábrica. La información presentada en este documento es exacta y fiable en cuanto a la descripción del producto y puede cambiar sin aviso. En casa de duda, prevalece el texto inglés.</p> <p>ADVERTENCIA Riesgo de descarga eléctrica, incendio, accidente grave o muerte:</p> <ul style="list-style-type: none"> - Desconectar la tensión de red antes de trabajar en la fuente de alimentación. Evite una posible reconexión involuntaria. - No realizar ninguna modificación o reparación de la unidad. No abrir la unidad. - Evitar la introducción en la carcasa de objetos extraños. - No usar el equipo en ambientes húmedos. No operar el equipo en ambientes donde se espere la formación de rocío o condensación. - No tocar durante el funcionamiento ni inmediatamente después del apagado. El calor de la superficie puede causar quemaduras graves.
Italiano Istruzioni di Installazione	<p>Leggere prima questa parte! Prima di collegare il sistema di alimentazione elettrica si prega di leggere attentamente le seguenti avvertenze. Conservare le istruzioni per la consultazione futura. Il sistema di alimentazione elettrica deve essere installato solo da personale competente e qualificato. Se durante il funzionamento si verificano anomalie o guasti, scollegare immediatamente la tensione di alimentazione. In entrambi i casi è necessario far controllare l'apparecchio dal produttore! I dati sono indicati solo a scopo descrittivo del prodotto e non vanno considerati come caratteristiche garantite dell'apparecchio. In caso di differenze o problemi è valido il testo inglese.</p> <p>AVVERTENZA Il mancato rispetto delle seguenti norme può provocare folgorazione elettrica, incendi, gravi incidenti e perfino la morte:</p> <p>Prima di eseguire interventi di installazione, di manutenzione o di modifica scollegare la tensione di rete ed adottare tutti i provvedimenti necessari per impedirne il ricollegamento non intenzionale.</p> <ul style="list-style-type: none"> - Non tentare di aprire, di modificare o di riparare da soli l'apparecchio. - Impedire la penetrazione di corpi estranei nell'apparecchio, ad esempio fermagli o altri oggetti metallici. - Non far funzionare l'apparecchio in un ambiente umido. Non far funzionare l'apparecchio in un ambiente soggetto alla formazione di condensa o di rugiada. - Non toccare quando acceso e subito dopo lo spegnimento. La superficie calda può causare scottature.
Português Instruções de instalação	<p>Leia primeiro! Recomendamos a leitura cuidadosa das seguintes advertências e observações, antes de colocar em funcionamento a fonte de alimentação. Guarde as Instruções para futura consulta, em casos de dúvida. A fonte de alimentação deverá ser instalada apenas por profissionais da área, tecnicamente qualificados. Se por acaso, durante a utilização ocorrer algum defeito de funcionamento ou dano, desligue imediatamente a tensão de alimentação. Em ambos os casos, será necessária uma verificação na Fábrica! Os dados mencionados têm como finalidade somente a descrição do produto, e não devem ser interpretados como propriedades garantidas no sentido jurídico. Em caso de dúvidas aplica-se o texto em inglês.</p> <p>ATENÇÃO A não observância ou o incumprimento dos pontos a seguir mencionados, poderá causar uma descarga elétrica, incêndios, acidentes graves ou morte:</p> <p>Antes de trabalhos de instalação, manutenção ou modificação, desligue a tensão de alimentação, protegendo-a contra uma nova ligação involuntária.</p> <ul style="list-style-type: none"> - Não efectue nenhuma modificação ou tentativa de reparação no aparelho. Quando necessário contacte o seu distribuidor. Não abra o aparelho. - Proteger a fonte de alimentação contra a introdução inadvertida de corpos metálicos, como por ex., cliques ou outras peças de metal. - Não usar o aparelho em ambientes húmidos. Não usar o aparelho em ambientes propensos a condensações. - Não tocar enquanto estiver em funcionamento, nem após a desligar. A superfície poderá estar quente e provocar lesões.