

# HSD04801

**2/3x 400 – 500Vac, 480W DC Power Supply, TS35mm DIN-Rail**



## Specification:

- Up to 92% efficiency
- Natural convection
- N+1 parallel operation
- Hold-up time >15ms
- Electronic Inrush Limiter <5A
- Precision current voltage curve
- Precise dynamic response on load change
- Designed for long life under full stress
- Strong input filters
- High reliability, shock & vibration proof
- Over Voltage and continuous short circuit protection
- PFC: EN61000-3-2
- EMI/EMS EN61000-6-2,3, EN55032 class B
- EN61010-1, EN61010-2-201, EN62368-1

Model	Voltage	Voltage Setting	Current
HSD04801.024	24Vdc	22,5 – 28,5Vdc	20,0A
HSD04801.036	36Vdc	32,8 – 38,0Vdc	13,3A
HSD04801.048	48Vdc	45,6 – 52,8Vdc	10,0A
HSD04801.060	60Vdc	57,0 – 72,0Vdc	8,0A



## Technical Concept

**The Camtec HSD 3-phase models are industrial high-performance power supplies „Made in Germany“. These power supplies are designed as a working horse for complex loads, and for battery charging. They are also applicable for a 2-phase setup.**

For more than 25 years the Camtec Power Supplies manufactures high-end switch mode power supplies in Germany. A field breakdown of below 0,004% over a 10-year period under review approves our ambitious quality concept. Each manufactured Camtec product passes 100% tests for each detailed function and a full-load Burn-In test.

Although it is not required from the safety norms our production applies a routine safety test to each manufactured device, even if it is an extra low-voltage model. The components in the assembled device pass stress aging to achieve an even level and to prevent from delayed failures. Our internal product engineering guidelines provide a clear target: Camtec product reputation must say „mount and forget“. Quality is never a mere promise for our team.

The HSD power supplies provide low noise and ripple, and a precise setting at high load changes. With an efficiency up to 91,5% the devices are highly energy efficient.

Equipped with high-end capacitors of outstanding lifetime our power supplies guarantee a very long and reliable operation time. The circuit design of the HSD series allows cope playing with complex loads. The internal protection circuits protect the power supply and the connected system, even in exceptional situations. The HSD series is protected from high transients by strong filters with high energy efficiency. All inputs and outputs are electrically isolated. The design specifications call for the highest standards of safety and interference suppression.

### Design Conception

The HSD power supply series realizes high power in a space-saving housing. Latest generation electrical devices relate to the high reliability of all CAMTEC products. The CAMTEC philosophy is, to employ 125°C low ESR ultra long-life capacitors where expedient to achieve a superior lifetime of the product. The HSD power supply is made for high reliable and demanding industrial applications like galvanic systems, professional DC-drives, UPS-System, and high dynamic load.

### Galvanic Isolation

The power supply is galvanic isolated between the input and the output. All features are connected to the DC power outputs.

### Thermal shutdown

The HSD units are featured with a thermal overload shut down and auto recovery behaviour.

### Over Voltage Protection

Ticker mode and auto recovery

### Short Circuit Protection

A continuous short circuit does not cause damage to the power supply. The HSD units deliver constant current and zero output voltage. They recover automatically after the short circuit is released.

### Open Circuit Protection

The HSD series is continuously open circuit protected. The device delivers a stable output voltage and no current. If a load is immediately connected to the device, the power supply stabilizes within 1ms. It does not overshoot the output voltage.

### Power Up Ramp

The devices have a soft start ramp when powering up. The device does not either overshoot the voltage nor does the output flutter independent if a load is connected or not.

### DC-ok Power Good Relay

The PG Relay connection indicates over temperature, low DC-voltage at the output, low AC supply voltage at the input, and the shutdown mode.

### Current Voltage Chart, CV & CC mode

The HSD series provides a perfect current voltage chart. It has no fold back or other abnormalities. The output voltage can drop down to zero volts when the power supply is overloaded. The unit delivers a stable and constant current to the outputs.

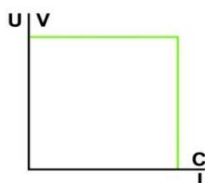

## Technical Data Table

AC Input Range	3xAC 340-575Vac / 2xAC 340-575Vac			
AC Input Frequency	47-63Hz			
AC Voltage Rated	3xAC 400-500Vac / 2xAC 400-500Vac			
DC Input Range	450-820Vdc			
AC Input Rated	3x400-500Vac ( $\pm 15\%$ ), 3x1.5-1.1A			
DC Input Rated	450-820Vdc, 1.6-0.9A			
DC Voltage Rated	24Vdc	36Vdc	48Vdc	60Vdc
DC Voltage Setting Range	22,5 - 28,5Vdc	32,8 - 38,0Vdc	45,6 - 52,8Vdc	57,0 - 72,0Vdc
DC Current Rated +40°C	22.0A	14.6A	11.0A	8.8A
DC Current Rated +60°C	20.0A	13.3A	10.0A	8.0A
DC Current Rated +70°C	15.0A	10.0A	7.5A	6.0A
DC Current Boost 60s +60°C	24.0A	16.0A	12.0A	9.6A
Over Voltage Protection	34Vdc	50Vdc	67Vdc	84Vdc
Ripple Noise 400-500VAC 20MHz	50mVpp	80mVpp	100mVpp	120mVpp
Load Regulation 0-100%	< $\pm 0,5\%$	< $\pm 0,5\%$	< $\pm 0,5\%$	< $\pm 0,5\%$
Response on Load Change	<1ms at load change 10-100%, 100-10%			
Continuous Power 3PH AC P <sub>nom</sub>	3xAC 400-500Vac = 480Wmax, -20°C...+60°C			
Continuous Power 2PH AC P <sub>nom</sub>	2xAC 400-500Vac, power derating, 75% of the rated power, -20°C...+60°C			
Cooling	Natural cooling			
Derating	+60°C...+70°C 2.5%/°C			
Efficiency	90% typically			
Short Circuit Proof	Yes			
Open Circuit Proof	Yes			
Base Load	None required (open circuit protected)			
Temperature Control	Yes, thermal shutdown & auto recovery (+70°C, outside measuring point distance 50mm)			
Hold Up Time	>15ms 400Vac mains buffering at full load			
Inrush Current Protection	< 3.5Aeff <5A peak (400-500Vac) active electronic inrush protection (no simple NTC)			
Recommended MCB	$\geq 2A$ curve B			
Soft Start	50ms typically			
Start-Up Delay	typ. 400ms			
Ambient Temperature	- 20°C...+70°C operating			
Storage Temperature	- 40°C...+85°C			
Environment	Humidity 95% non-condensing @ 25°C, climate class. 3k3, pollution degree 2			
ROHS	2011/65/EU, (EU)2015/863			
REACH	EG No. 1907/2006			
EMI	EN55032 class B, EN61000-6-3, PFC: EN61000-3-2			
EMS	EN61000-6-2			
Safety	EN61010-1, EN61010-2-201, EN62368-1 (with $\leq 3x420Vac$ ), EN60950-1, EN60204-1			
Protection Class I	PE connection required			
Maximum Operation Altitude	2000m (6561 ft.) above sea level			
Isolation Input to Output	3000Vac			
Isolation Input to Case	2500Vac			
Isolation Output to Case	500Vdc, $\geq 48Vdc = 1500Vdc$			
MTBF (IEC61709)	600000h (Meantime Between Failures: statistic time between failures after repairs)			
MTTF (IEC61709)	152012h (Meantime To Failure: statistic time to ever fails)			
Dimensions (HxWxD)	130x150x115,6mm			
Weight	1,9kg / 4,2lbs			
AC-Input & DC-Output Connections	Spring-type terminal with cable protection 0,5...6mm <sup>2</sup> 21...10AWG according with IEC/EN60664-1, IEC/EN61984 Use copper conductors only. Tightening torque per terminal block is 0.5 - 0.6 Nm / 4.5 - 5.3 lbf-in			

## Manual and Technical Details

### Temperature Derating

The maximum ambient temperature during operation is + 70°C. If the over temperature protection is activated, the power supply is switched off.

The measuring point is 50mm outside the power supply. The power supply unit starts automatically when it has cooled down.

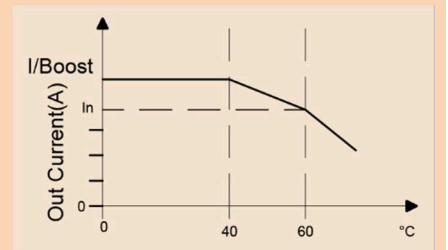

### Parallel Operation & N+1 Decoupling

To increase the overall power of the power supply, two or more devices of the same model with the same output voltage may be operated in parallel. We recommend using a busbar for the DC power connector. Make sure that the cable lengths and cable cross-sections of all power supplies to the busbar or to the star point are identical. If you want to use the sensing function, connect it also to the star point or busbar. To avoid measurement errors, select the line length from the neutral point or from the busbar to the load as short as possible and use the maximum possible conductor cross-section.

The HSD models have no internal O-ring diode, to operate the devices N+1 redundant. Such, we recommend using our RED00202 DIN-rail redundant decoupling modules.

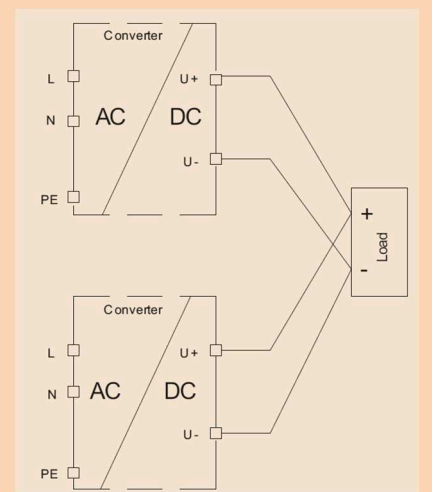

### C/V Current Voltage Behaviour

The HSD series provides a perfect current voltage chart. It has no fold back or other abnormalities. The output voltage can drop down to zero volts when the power supply is overloaded. The unit delivers a stable and constant current to the outputs.

When the output voltage is set to the maximum demanded value and the current limit circuit acts, the output voltage drops linear down to zero and the unit delivers constant current.

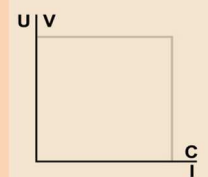

### Coating Option

We offer the HSD-series with optional coating. It is to be used in e.g. dusty, dirty, high humidity, or in awaiting quick temperature changes. Short circuit and corrosion at print board lines and at solder points can be prevented. The coat itself is a transparent acrylic resin. Peters SL 1306 N-FLZ (transparent) IEC60216-1 2001, IPC-CC-830B, UL listed as permanent coating File No.: E80315 , UL94V-0

### Technical Data Table – Power OK Connection & Voltage Setting

Feature	Technology	Details and Connections	Section	Isolation
Potentiometer Voltage	1 turn	High precision	U adj	3000Vac to input & output
Power Good Relay	make contact	AWG24 – AWG14 / 0,25 – 2,5mm <sup>2</sup>	DC-ok	3000Vac to input & output

## DC Voltage setting range

Rated DC Voltage	24Vdc	36Vdc	48Vdc	60Vdc
DC Voltage Setting Range	22,5-28,5Vdc	32,8-38,0Vdc	45,6-52,8Vdc	57,0-72,0Vdc
Rated DC Current +40°C	22.0A	14.6A	11.0A	8.8A

The DC voltage can be adjusted with a precision 1 turn potentiometer with low temperature fading. The factory setting is to the rated voltage from the table above.

## DC-OK Relay

The DC ok relay indicates if the output voltage is low and if the AC voltage is low. The contact is galvanic insulated to the AC input and the DC output connections. The isolation is 3000Vac with a forced isolation and covers the overall adjustment range of the HSD models. If the DC voltage is ok the relay is closed, if the power supply unit is in false operation the relay is open. Considering the lower and the upper margin of the AC voltage detection it is to say that the HSD series starts at  $\geq 310\text{Vac}$ . The unit starts with  $\geq 420\text{Vdc}$  when a DC voltage applies to the input. When the input AC voltage falls below these values, the relay opens. Contact Rating  $\leq 48\text{Vdc}/500\text{mA}$   $\leq 30\text{Vdc}/500\text{mA}$

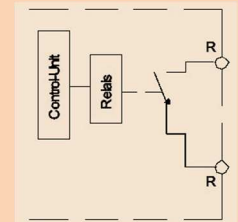

## DC OK Indication

Power Supply Status	Normal	Over Temperature	AC Low [V]	DC Low [V]
Relay Operation status	Closed	Open	Open	Open

## Inrush Current Limiter

The unit is featured with an electronic inrush current limiter 3,5Arms / 5Apeak. The built-in circuit is a very precise limiter and no simple NTC thermistor solution. The circuit works with an accuracy of  $\pm 10\%$ . The accuracy is independent from the ambient temperature and from the number of switch-on sequences. The quickest recommended MCB is B-type 2A. The smallest power relay or a contactor in front of the HSD must cope 5A peak current. The inrush duration is 20ms and the overall power up time of the unit is 400ms. See the below drawings for technical information.

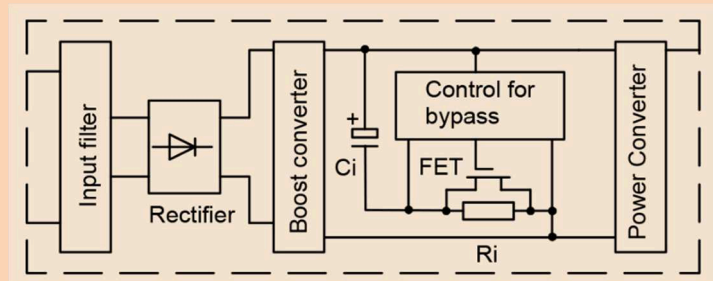
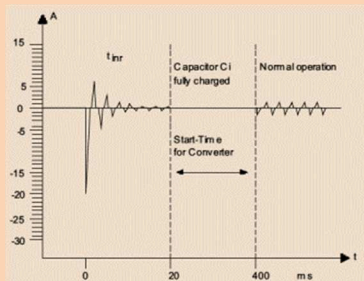

## Electrical Safety (Factory-Test / Field-Test Owner)

	T	A	B	C <sup>1)</sup>	D
Type Test	60s	2500Vac	3000Vac	500Vdc	500Vdc
Factory Test	5s	2500Vac	1500Vac	500Vdc	500Vdc
Field Test	2s	2500Vac	1500Vac	500Vdc	500Vdc
Cut-off current setting	>15mA	>15mA	>1mA	>1mA	>1mA

<sup>2)</sup>  $\geq 48\text{Vdc} = 1500\text{Vdc}$

Type and factory test are the manufacturer. While repeating damage can happen to the power supply unit. For the field test (owner) follow the below instruction:

- Use suitable test equipment, raising the voltage slowly
- Short circuit L1 and N, and all the DC output terminals.
- Use only test voltages of 50/60Hz. The outputs are unearthed and therefore they have no resistance to GND/PE.
- If the residual voltage is  $\geq 60\text{Vdc}$ , observe the safety standards. Use only specially insulated screwdriver to trim the  $U_a/I_a$ .

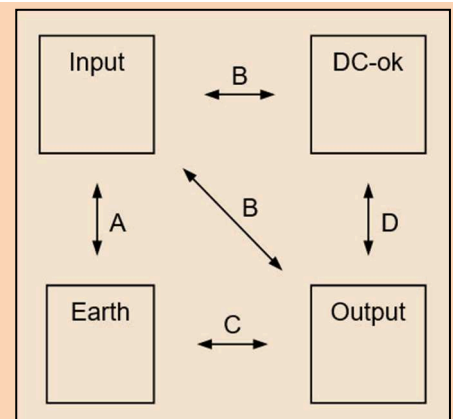

**Mechanics & Installation Instruction of the HSD**

Stable metal/aluminium housing IP20. To allow adequate convection, a free air space of 50mm (top/bottom) and 10mm (sidewalls) is required; and for active devices 15mm space from the sidewalls. For proper air convection it is necessary to install the HSD.

One can use the DIN-Rail installation (equipped standard) with our patented 35mm DIN-Rail bracket according to EN60715. It is easy to mount/dismount while snapping it onto the 35mm DIN-Rail - no tools necessary.

**It is not allowed to install the HSD in other mounting direction then below drawings.**

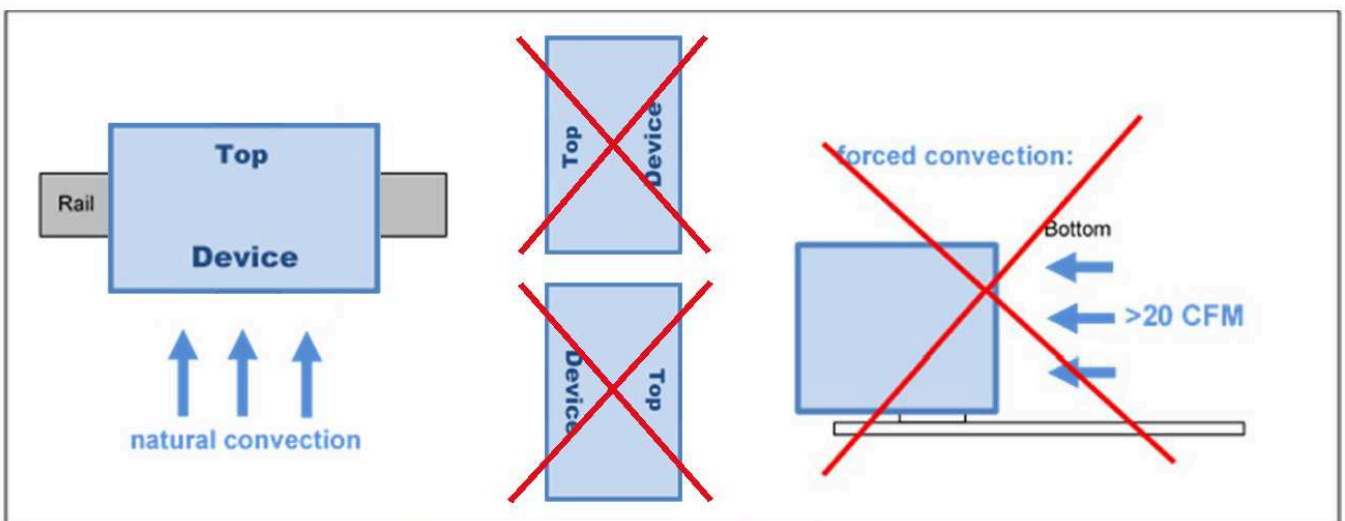
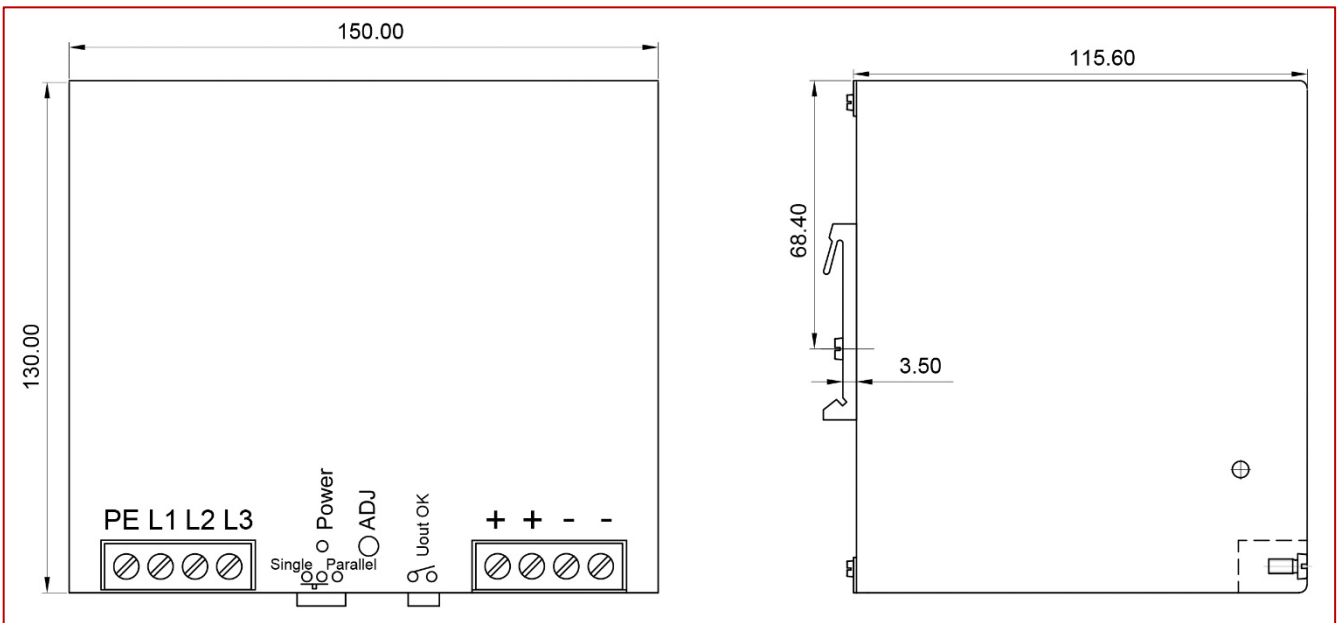

Mounting Instruction: recommended air flow space below and above is 50mm (2 Inch)

## Connections

### Input Connection

Pin	Name	Type	Function	Remarks
1	PE	-	Earth	Protective Earth PE must be connected before taking device into operation!
2	L1	Input	Phase 1	With 2 phase operation 40% derating nominal power = 330W
3	L2	Input	Phase 2	
4	L3	Input	Phase 3	

### Output Connection

Pin	Name	Type	Function	Remarks
1	+	Output	Vout +	
2	+	Output	Vout +	
3	-	Output	Vout -	
4	-	Output	Vout -	
5	Uout OK	Relay	Break	<48Vdc/500mA, galvanic separation <60Vdc, >60Vdc no save contact separation
6	Uout OK	Relay	Break	Break contact

### Clamping Yoke Connector Specifications

	Input / Output connections	Optional Power OK Connection Plug
Tightening torque min. – max.	0,5 – 0,6Nm (blade 1,0x5,5 DIN5264 )	0,4 – 0,5Nm (blade 0,6x3,5 PH1 PZ1)
Touch-safe protection acc. to DIN VDE 0470	IP20 plugged/ IP10 unplugged	Not applicable
Clamping range, min. – max.	0,18 – 6mm <sup>2</sup> / AWG26 – AWG10	0,2 – 4,0mm <sup>2</sup> / AWG26 – AWG12
Solid, H05(07) V-U min. – max.	0,18 – 6mm <sup>2</sup>	0,2 – 4,0mm <sup>2</sup>
Stranded, H05(07) V-U min. – max.	0,22 – 4 mm <sup>2</sup>	Not applicable
Flexible, H05(07) V-U min. – max.	Not applicable	0,2 – 4,0mm <sup>2</sup>
w. plastic collar ferrule, DIN 46228 pt 4 min. – max.	0,5 – 2,5mm <sup>2</sup>	0,2 – 2,5mm <sup>2</sup>
w. wire end ferrule, DIN 46228 pt 1, min. – max.	0,5 – 4mm <sup>2</sup>	0,2 – 4,0mm <sup>2</sup>
Plug gauge in accordance with EN 60999 a x b; ø	3,6 x 3,1mm; 2,7mm	2,8 x 2,4mm; 2,5mm
Pitch (P)	9,52mm	5,08mm

### Wire Stripping Length (fine wired)

Nominal Cross Section	Wire End Ferrule	Stripping Length	Wire End Ferrule	Stripping Length
0,25mm <sup>2</sup>	H0,25/5	5mm	H0,25/10 HBL	8mm
0,5mm <sup>2</sup>	H0,5/6	6mm	H0,5/12 OR	8mm
1,0mm <sup>2</sup>	H1,0/6	6mm	H1,0/12 GE	8mm
2,5mm <sup>2</sup>	H2,5/12	12mm	H2,5/19D BL	14mm
4,0mm <sup>2</sup>	H4,0/12	12mm	H4,0/20 GDR	14mm
6,0mm <sup>2</sup>	H6,0/20	12mm	H6,0/20 SW	14mm
10,0mm <sup>2</sup>	H10,0/12	12mm	H10,0/22 EB	15mm

The length of ferrules is to be chosen depending on the rated voltage. The outside diameter of the plastic collar should not be larger than the pitch (P)

## Ordering Information

### Ordering Codes

Product Code	Information	Article Number
HSD04801.024(R2)	24V	3041055001CA
HSD04801.036(R2)	36V	3041055007CA
HSD04801.048(R2)	48V	3041055008CA
HSD04801.060(R2)	60V	3041055009CA
Optional Power OK Connector	Optional, 2poles Clamping Yoke Connector 180° cabling (10pcs per pack)	3520037

**Safety regulations: Please read these instructions completely before using the equipment. Keep these instructions on to hand. The device may only be operated by trained specialist staff.**

**Installation:**

- 1) The device is designed for devices and systems that meet the standard requirements for hazardous voltages, power, and fire prevention.
- 2.) Installation and service only by trained persons. The AC power must be switched off. The work is to be labelled; accidental reconnection of the system must be prevented.
- 3.) Opening the device, its modification, loosening bolts, or operation outside the specified herein specification or in an unsuitable environment, has the immediate loss of warranty to follow. We disclaim any responsibility for any resulting damage to persons or things.
- 4.) Note: The device must not be operated without an upstream circuit breaker (CB). We recommend the use of B-Type 2A. It is prohibited to use the unit without PE. It may be necessary upstream device has a power switch.

**Warning:**

**Non-compliance these warnings can result in fire and serious injury or death.**

1. Never operate device without PE connection.
2. Before connecting the device to the AC network, make wires free of voltage and assure accidentally switch on.
3. Allow neat and professional cabling.
4. Never open nor try to repair the unit. Inside are dangerous voltages that can cause electrical shock hazard.
5. Avoid metal pieces or other conductive material to fall into the item
6. Do not operate the device in damp or wet conditions
7. Do not operate the unit under EX-conditions



All parameters base on 5 minutes run-in @ full load / 25°C / 230Vac 50/60Hz, as otherwise stated.