

# AC-DC Converter

**POWER  
SOLVE**

## PEK3000HV Series 3000W Active PFC Programmable Single Output

[www.powersolve.co.uk](http://www.powersolve.co.uk)

### Features

- Universal AC Input / Full Range
- Programmable Output Voltage (0%-105%)
- Programmable Output Current (0%-105%)
- Constant Current Limit
- Intelligent LED Indicators
- Forced current sharing for parallel operation
- Power OK signal (Power good, logic low)
- Remote ON/OFF, Remote Sense function
- OVP, OLP, OTP, SCP, Fan Failure Protections
- Selectable +5V/0.5A or +9V/0.3A Auxiliary Output
- Global control via RS232
- Remote Setting Multiple PSU's via RS232, RS485 & I<sup>2</sup>C



### Electrical Specification

Input Voltage	90-264VAC full range, 47-63Hz / 127-370VDC. (refer to derating curve for low AC input derating)
Power Factor	0.95 at 230VAC / 0.98 at 115VAC at full load
AC Input Current (typ.)	19.7A at 115VAC (2000W) / 14.5A at 230VAC (3000W)
Inrush Current	33A at 115VAC / 65A at 230VAC
Leakage Current	<1.0mA at 240VAC
Output Voltage	See Table
Output Current	See Table
Voltage Tolerance	±2%
Voltage Adjust Range	±5.0% typical adjustment by potentiometer
Overload Protection	>105% of rated output power. Protection type: Constant current limiting
Overvoltage Protection	Variable OVP, 120% ±7% Vout. Output latches off, recycle AC input to recover or inhibit (refer to VCI VS OVP curve)
Over Temperature Protection	Shuts down output, recovers automatically (85°C ±5°C detect on heatsink on primary & secondary side)
Auxiliary Power	+5V/0.5A or +9V/0.3A auxiliary output selected by user
Remote ON/OFF Control	External switch or NPN transistor to turn on/off
Power OK Signal	Open drain signal low when PSU turns on. Max. sink current 20mA, max drain voltage 40V
Output Voltage Programming	Adjustment of output voltage between 0-105% of rated output
Output Current Programming	Adjustment of output current between 0-105% of rated output
Operating Temperature Range	-25°C to +60°C. Above 50°C, derate linearly to 50% load at 60°C
Operating Humidity	20-90% RH non-condensing
Storage Temperature Range	-40°C to +85°C
Storage Humidity	10-95% RH non-condensing
Temperature Coefficient	±0.02%/°C (0-50°C)
Vibration	Compliance to IEC60068-2-6, IEC60068-2-64. 10-500Hz, 5G 10 mins / 1 cycle, period for 60 mins. along X, Y, Z axes
Safety Standards	Meets UL60950-1, EN60950-1
Withstand Voltage	I/P-O/P: 3KVAC (4242VDC), I/P-FG: 1.5KVAC (2121VDC), O/P-FG: 0.5KVAC (707VDC)
Isolation Resistance	I/P-O/P, I/P-FG, O/P-FG: 100MΩ / 500VDC
EMI Conduction & Radiation	Certified to EN55022, EN61204-3, EN61000-6-3
Harmonic Current	Certified to EN61000-3-2, EN61000-3-3
EMS Immunity	Certified to EN55024, EN61204-3, EN61000-6-1, EN61000-4-2, -3, -4, -5, -6, -8, -11
Cooling	Internal fan controlled by power rating & temperature, allow 50mm clearance at each end for airflow
Dimensions	280(L) x 170(W) x 63.5(H) mm
Weight	3.8kg

### Notes:

1. All parameters NOT specifically mentioned are measured at 230VAC input, rated load and 25°C ambient temperature
2. Ripple and noise are measured at 20MHz bandwidth by using a 12" twisted pair wire terminated with a 0.1µF ceramic & 47µF electrolytic capacitors across the output
3. Tolerance includes set up tolerance, line regulation and load regulation
4. Derating is required at low input voltages. Refer to derating curve
5. When parallel connected, only one unit may operate if the total output load is less than 5% of rated load
6. The power supply is considered a component which will be installed into a final equipment. The final equipment must be re-confirmed that it still meets EMC Directives
7. Withstand Voltage test is done without enclosure

# AC-DC Converter



[www.powersolve.co.uk](http://www.powersolve.co.uk)

## Output Voltage and Current Ratings

MODEL	OUTPUT VOLTAGE	MAX OUTPUT CURRENT	RIPPLE & NOISE	LINE REG.	LOAD REG.	POWER Max.	EFF.
PEK3000HV-150	150V	20A	1500mV p-p	±1%	±1%	3000W	93%
PEK3000HV-200	200V	15A	2000mV p-p	±1%	±1%	3000W	93%
PEK3000HV-250	250V	12A	2500mV p-p	±1%	±1%	3000W	93%
PEK3000HV-300	300V	10A	3000mV p-p	±1%	±1%	3000W	93%
PEK3000HV-400	400V	7.5A	4000mV p-p	±1%	±1%	3000W	93%

## Mechanical & Connection Details

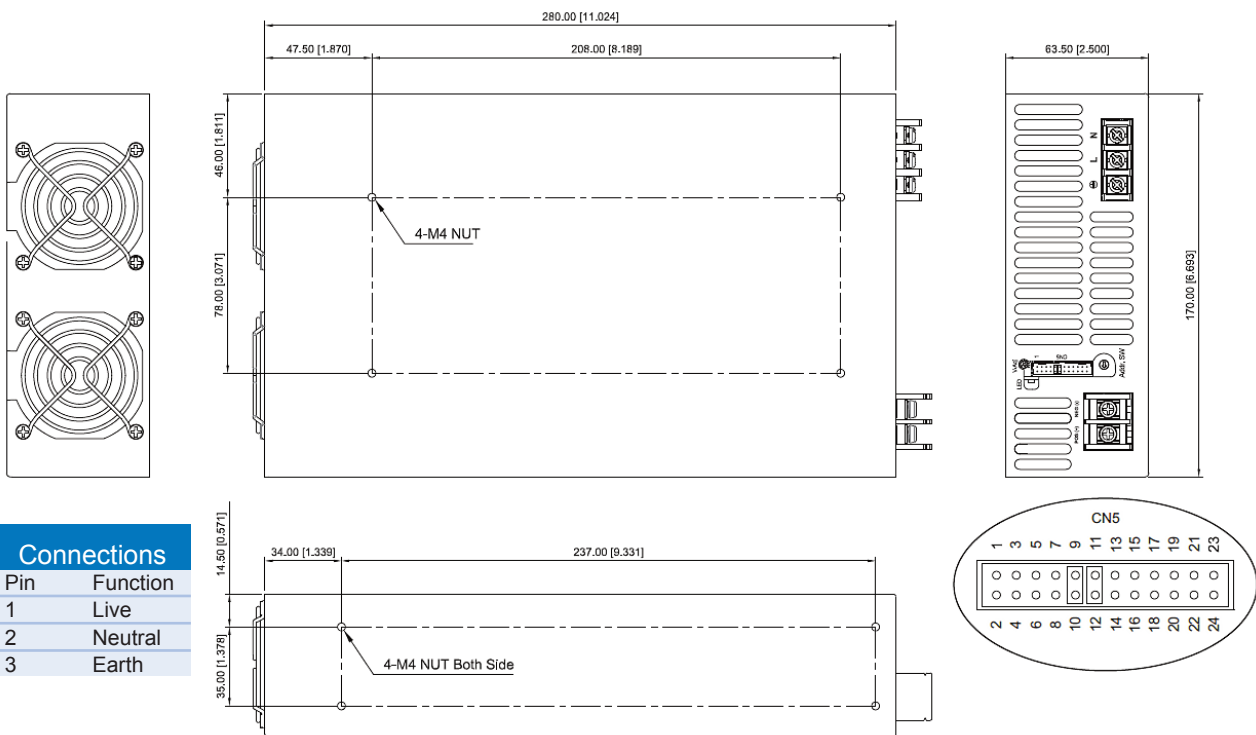

### Connections

Pin	Function
1	Live
2	Neutral
3	Earth

## Function Description of CN2, Control Connector

Pin No.	Function	Description	Mating Housing	Terminal
1, 2, 3, 4	N.C.	Not Connected		
5	POK	Power OK		
6, 10, 14, 16, 18, 22	GND	Ground		
7	PAR	Parallel Operation Current Share		
8	VSET	Aux. Output Setting		
9	EN-	Inhibit ON/OFF (-)	JST	JST
11	EN+	Inhibit ON/OFF (+)		
12, 17, 21	AUX	+5V / 0.5A or +9V / 0.3A Auxilliary Power	PHDR-24VS	SPHD-002T-P0.5
13	ACI	I Program	or equivalent	or equivalent
15	VCI	V Program		
19	SCL	Serial Clock used in the I2C interface		
20	SDA	Serial Data used in the I2C interface		
23	N.C.	For RS232 Transmission Function		
24	N.C.	For RS232 Receiver Function		

# AC-DC Converter



[www.powersolve.co.uk](http://www.powersolve.co.uk)

## LED Status

LED Colour	LED Signal	Status
Green LED	Solid	Power OK (Local mode)
Orange LED	Solid	Power OK (Remote mode)
Green LED	Slow Blink	Power Standby
Red LED	Fast Blink	Over Voltage Protection (OVP)
	Solid	Over Load Protection (OLP)
	Slow Blink	Over Temperature Protection (OTP)
	Intermittent Blink	Fan Failure
	Interlace Blink	Power Failure

Local mode: Use ACI / VCI to control output current and voltage  
 Remote mode: Use RS232 or I<sup>2</sup>C command to control output current and voltage

## De-rating Curve

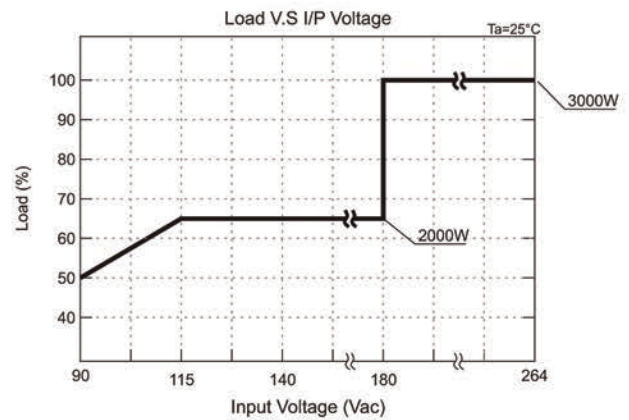
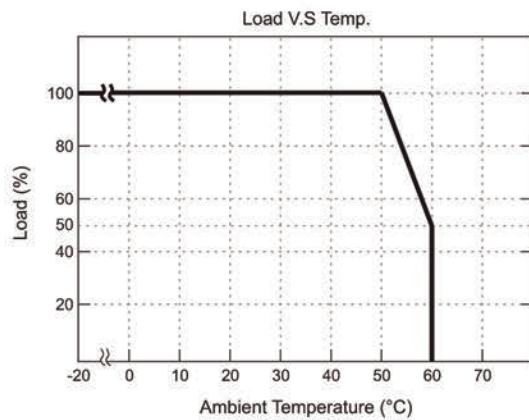

## Control Voltage Input vs OVP Curve

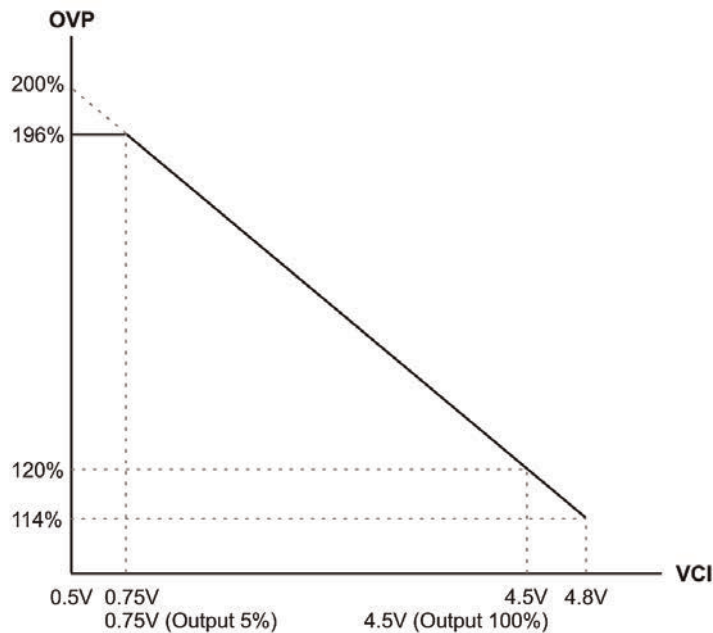

# AC-DC Converter



www.powersolve.co.uk

## Programming Input

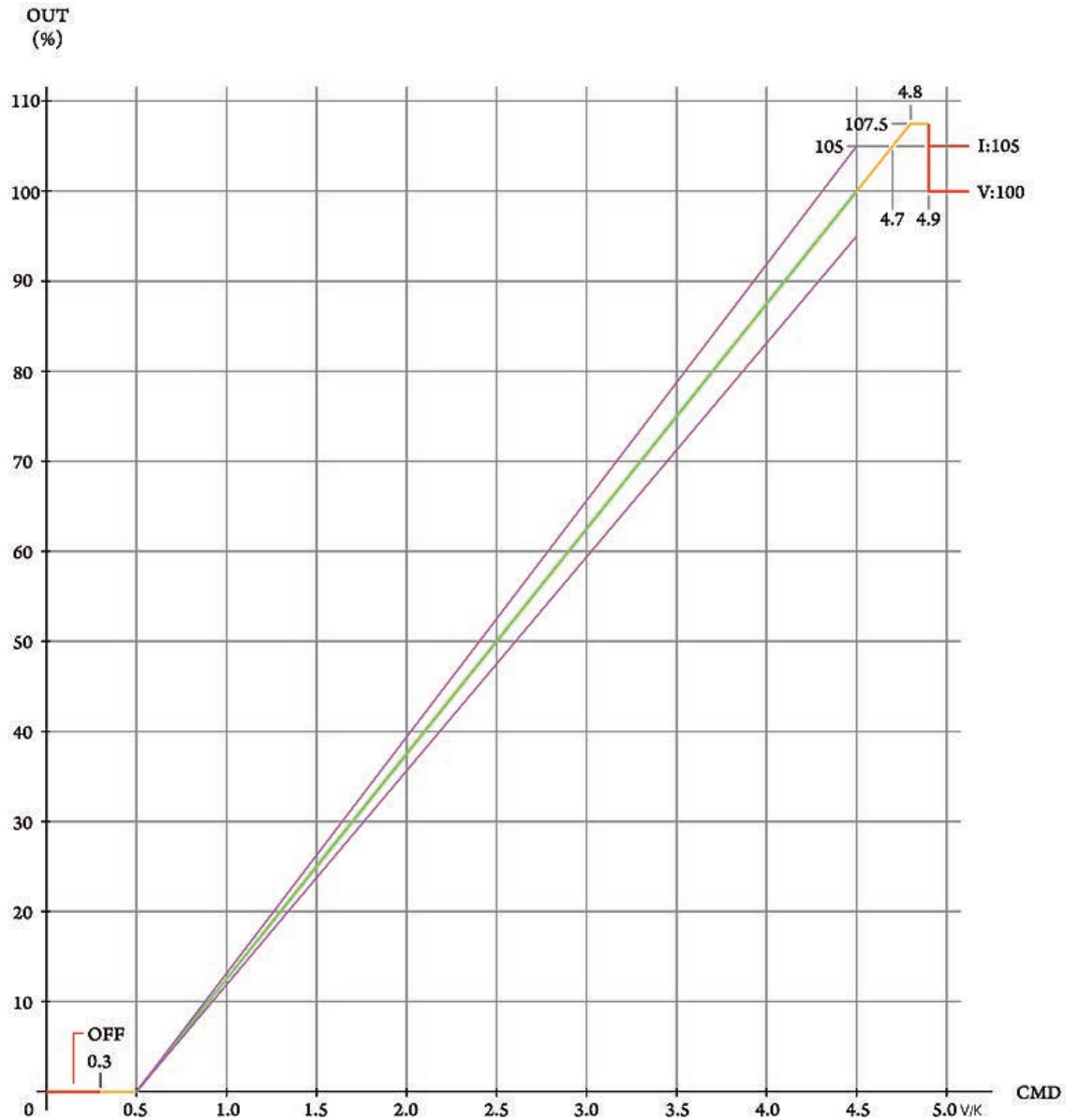

External Voltage (VDC)



External Resistor (K.Ω)

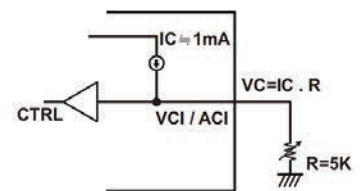
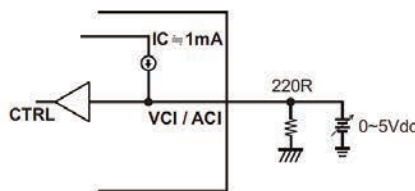
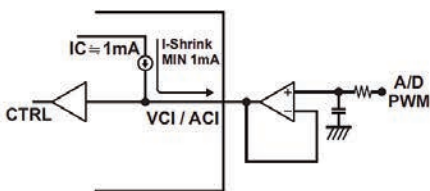



# AC-DC Converter



www.powersolve.co.uk

## Remote ON/OFF

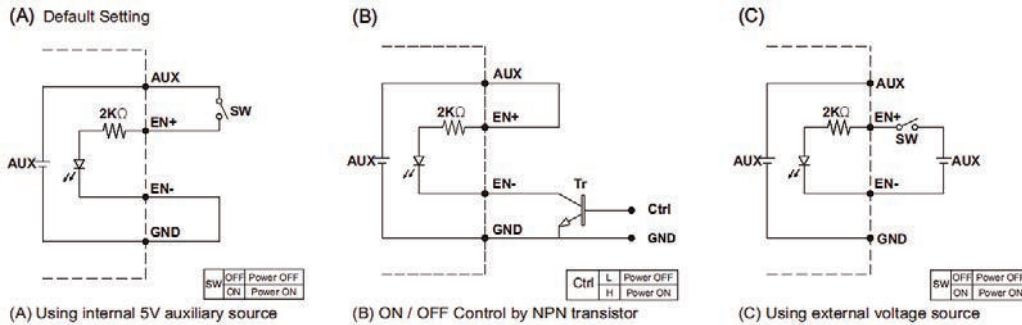

\*GND shown in above diagram is referring to the GND of CN2, not the Grounding from main power(NEG-).\*

## Power OK Signal

\*The grounding of "AUX" power and P.OK signal should be connected to "GND" port. If "VO-" is connected as Grounding, make sure to short the GND and VO- ports.

\*Place an additional capacitor to have a better performance of auxiliary power operation.

Open drain signal low when PSU turns on, Max. P.OK sink current: 20mA, Max. drain voltage: 40V.

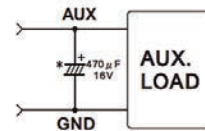
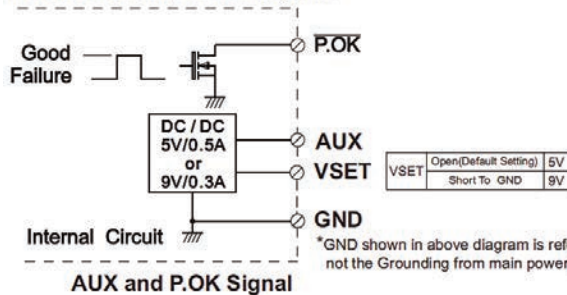

Do NOT exceed 5V/0.5A or 9V/0.3A

## Functions

### 1. Current Sharing

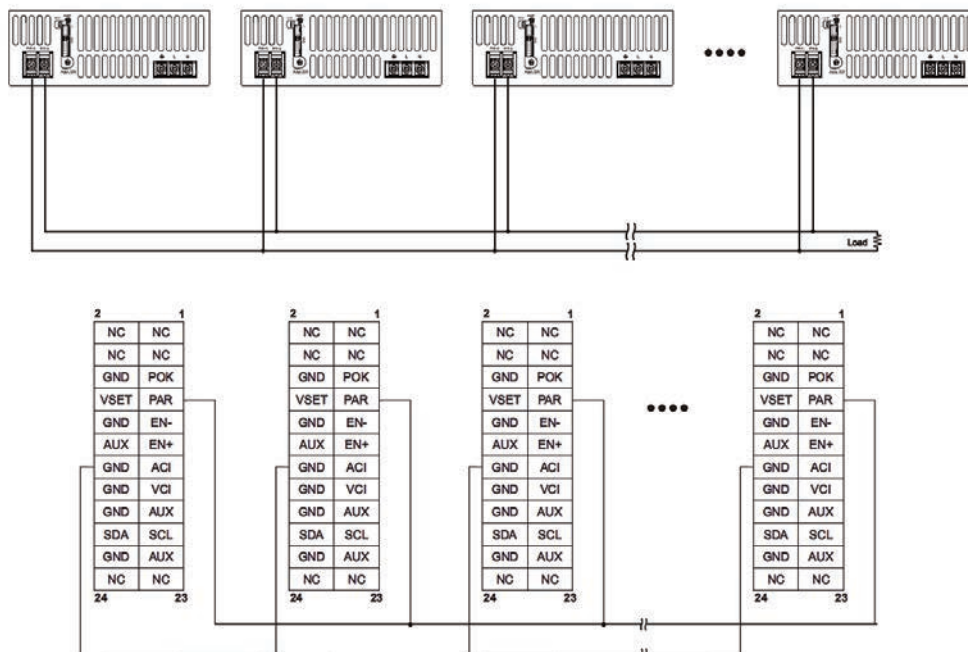

# AC-DC Converter

**POWER  
SOLVE**

[www.powersolve.co.uk](http://www.powersolve.co.uk)

## Installation Instructions

### 1. Mounting Directions

1-1 Recommended standard mounting methods:

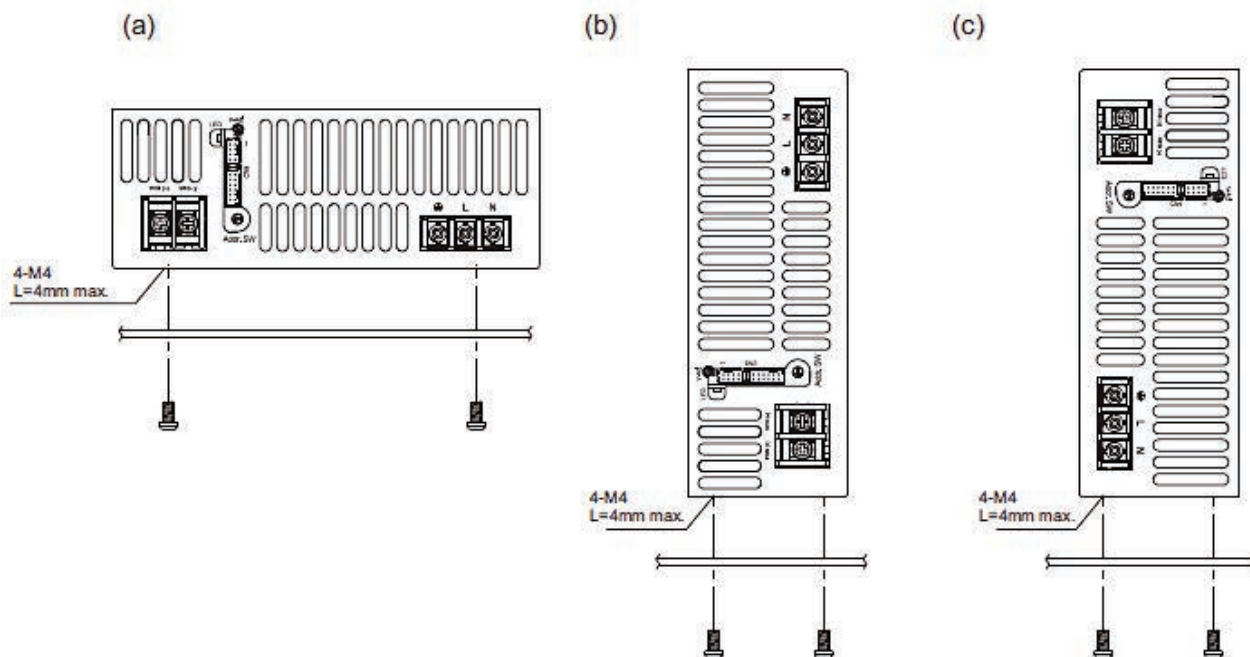

### 2. Mounting Method

- 2-1 There are ventilating holes on the front and back side panels, do not obstruct; allow 50mm at least for air flow.
- 2-2 The Maximum allowable penetration of screw is 4mm. Incomplete threading should not be penetrated.
- 2-3 Recommended the torque of mounting screw:  
M4 screw: 1.27N · m (13.0kgf · cm)

