

### 750 Watts

- Low Profile, Compact Size
- Suitable for 1U Applications
- 900 W Peak Power Rating for 100 ms
- Universal 80 - 264 VAC Input (300 VAC for 5 s)
- IT/Industrial & Medical (2 x MOPP) Safety Approvals
- 5 V/3 A Standby Output
- 1.0 W Standby Power
- Intelligent Fan Speed Control
- -40° C to +70° C Operation
- PowerFail, Inhibit, Remote Sense & Current Share
- 3 Year Warranty



#### Dimensions:

##### GSP750:

10.0 x 4.0 x 1.65" (254.0 x 101.6 x 41.91 mm)

The GSP750 offers a full 750 W of output power in a very small mechanical footprint while providing peak power to up to 900 W, a 5 V standby output with 3 A current capability and an input standby power draw of <1.0 W when the inhibit is activated.

Approved for both IT/Industrial and medical applications the series has output versions from 12 V to 48 V. Cooling fans are intelligently controlled to reduce acoustic noise in the system and the GSP750 provides up to 50 W without forced cooling, allowing the fans to be switched off, providing silent running during periods of lower system loading or system standby conditions.

### Models & Ratings

Output Voltage	Output Current V1	Standby Supply		Max Output Power		Model Number
		<50 W Load (fans off)	>50 W Load (fans on)	Nom	Peak <sup>(1)</sup>	
12.0 VDC	62.5 A	5 V/1 A	5 V/3 A	750 W	900 W	GSP750PS12-EF
24.0 VDC	31.3 A	5 V/1 A	5 V/3 A	750 W	900 W	GSP750PS24-EF
48.0 VDC	15.6 A	5 V/1 A	5 V/3 A	750 W	900 W	GSP750PS48-EF

### Notes

1. Peak power available for 100 ms maximum with a 10% duty cycle. The average power in a period should be equal or less than the nominal power.

### Input

Characteristic	Minimum	Typical	Maximum	Units	Notes & Conditions
Input Voltage - Operating	80	115/230	264	VAC	Derate output power <90 VAC. See fig 1.
Input Voltage - Fault condition			300	VAC	5 second max
Input Frequency	47	50/60	63	Hz	
Power Factor		>0.9			230 VAC, 100% load
Input Current - Full Load		8.7/4.35		A	115/230 VAC
Inrush Current		60		A	
No Load Input Power			1	W	All models, when inhibit activated
Earth Leakage Current		80/220	250	µA	115/230 VAC/50 Hz Typ., 264 VAC/60 Hz Max.
Input Protection	F16.0 A/250V internal fuse in both lines				

### Output

Characteristic	Minimum	Typical	Maximum	Units	Notes & Conditions
Output Voltage - V1	12		48	VDC	See Models and Ratings table
Initial Set Accuracy			±1	%	50% load, 115/230 VAC
Output Voltage Adjustment			+1,-3	%	
Minimum Load	0			A	No minimum load required
Start Up Delay		1.0	2.0	s	115/230 VAC full load from input AC turn on
Hold Up Time	10			ms	100% load
Drift			±0.5	%	After 20 min warm up
Line Regulation			±0.5	%	90-264 VAC
Load Regulation		0.2	1.0	%	0-100% load
Transient Response			4	%	Recovery within 1% in less than 500 $\mu$ s for a 50-75% and 75-50% load step
Over/Undershoot			5	%	
Ripple & Noise		0.5	1.5	% pk-pk	20 MHz bandwidth
Overvoltage Protection	115		140	%	Vnom DC. Output 1, recycle input to reset
Overload Protection	110		150	% I nom	See fig. 2. Trip and Restart
Short Circuit Protection					Shutdown & auto recovery
Temperature Coefficient			0.05	%/°C	
Overtemperature Protection					Shutdown & auto recovery

### Input Voltage Derating Curve

Figure 1

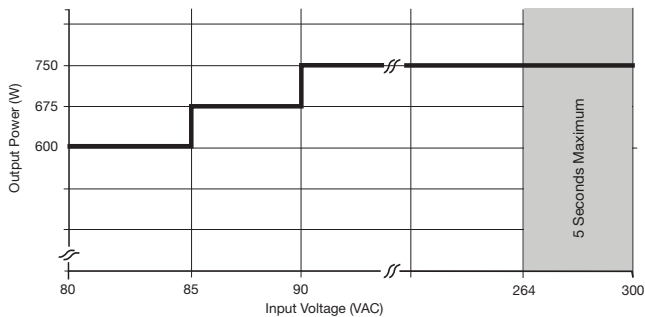

### Output Overload Characteristic

Figure 2

GSP750PS12 example (others similar).

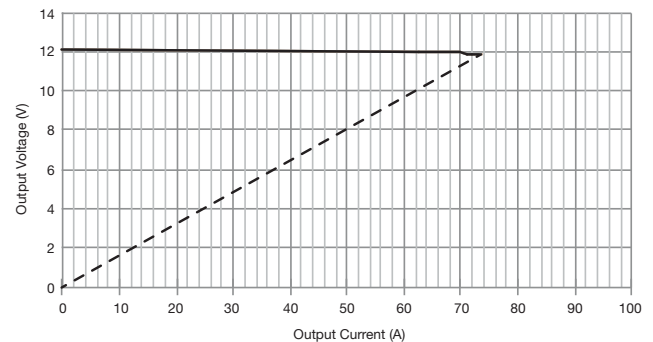

### General

Characteristic	Minimum	Typical	Maximum	Units	Notes & Conditions
Efficiency		90		%	230 VAC Full load (see fig.3-5)
Isolation: Input to Output Input to Ground Output to Ground	4000			VAC	2 x MOPP
	1500			VAC	1 x MOPP
	500			VDC	1 x MOPP at 48 VDC
Switching Frequency		65		kHz	PFC Converter
	50	90	200		Main Converter
		100			Standby Converter
Power Density			11.7	W/in <sup>3</sup>	
Mean Time Between Failure		186		kHrs	MIL-HDBK-217F, Notice 2 +25 °C GB
Weight		2.97 (1.35)		lb (kg)	

### Efficiency Vs Load

Figure 3  
12 V Models

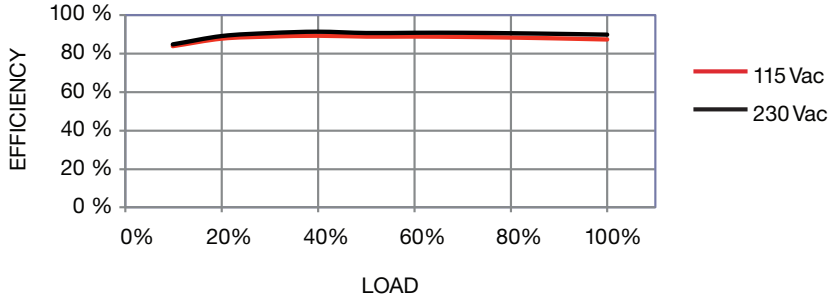

Figure 4  
24 V Models

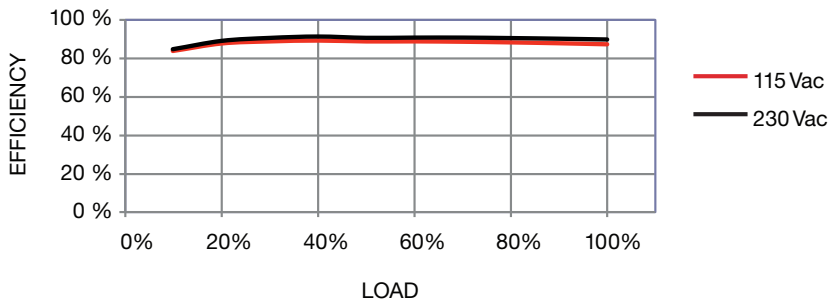
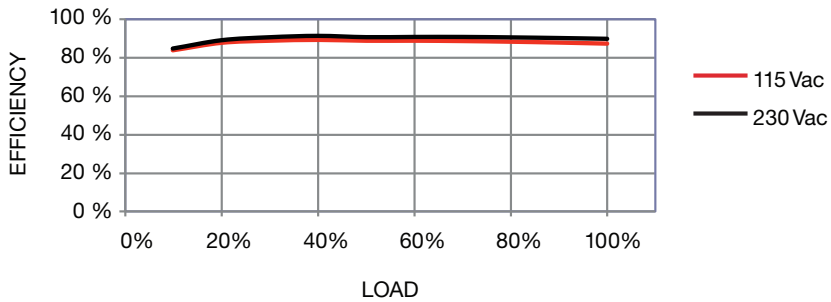

Figure 5  
48 V Models



### Signals & Controls

Characteristic	Notes & Conditions
Power Fail (PF)	Open collector referenced to negative sense, transistor normally on when power is good (see fig. 5); power is considered good when PFC bulk capacitor voltage is normal. PF: Provides $\geq 5$ ms warning of loss of output from power failure.
Inhibit	Uncommitted isolated optocoupler diode, powered diode inhibits both V1 and fan supply (see fig. 6). During inhibit the standby supply and current should be limited to 1 A for thermal reasons.
Output Good	LED Indicator
Fan Speed Control	The fan speed is set to one of 4 states (high, mid, low or off) dependant on the internal power supply ambient temperature, input voltage and output load at any given time.
Standby Supply	5V/3A Isolated supply present when AC applied.
Remote Sense	Compensates for 0.5 V total voltage drop.
Current Share	Connecting pins 5 or 6 on one unit to pins 5 or 6 on another like voltage unit will force the current to be shared within 10% between the two outputs. Up to three units can share current. (see fig. 7)

### Power Fail (PF)

Figure 6

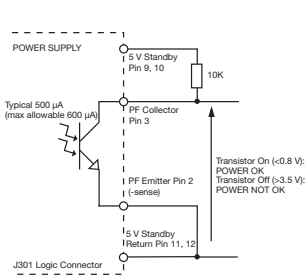

### Remote On/Off (Inhibit)

Figure 7

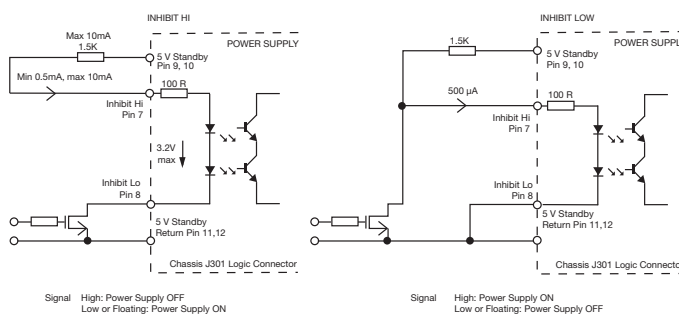

### Current Share

Figure 8

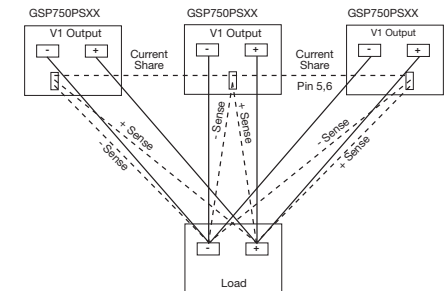

### Environmental

Characteristic	Minimum	Typical	Maximum	Units	Notes & Conditions
Operating Temperature	-40		+70	$^{\circ}\text{C}$	Start up at $-40^{\circ}\text{C}$ . See derating curve, fig. 8
Storage Temperature	-40		+85	$^{\circ}\text{C}$	
Humidity	5		95	%RH	Non-condensing
Operating Altitude			5000	m	
Acoustic Fan Noise		65.0		Lw db(A)	Full Speed
		56.0		Lw db(A)	Mid Speed
		42.0		Lw db(A)	Low Speed
Shock					$\pm 3 \times 30\text{g}$ shocks in each plane, total 18 shocks. $30\text{g} = 11\text{ms}$ ( $\pm 0.5\text{msec}$ ), half sine. Conforms to EN60068-2-27 & EN60068-2-47
Vibration					Single axis 10 - 500 Hz at 2g sweep and endurance at resonance in all 3 planes. Conforms to EN60068-2-6

### Thermal Derating Curve

Figure 9

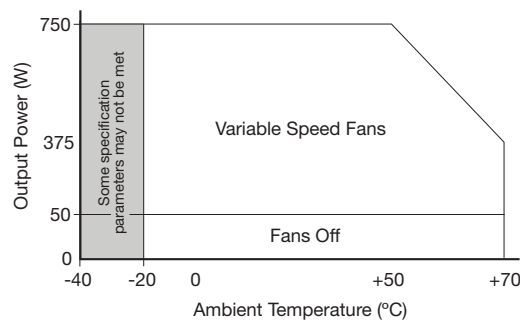

### EMC: Emissions

Phenomenon	Standard	Test Level	Notes & Conditions
Conducted	EN55011/32	Class B	
Radiated	EN55011/32	Class A	Class B with Wurth 742 712 22(S) on input cable and Wurth 742 715 4(S) on output cable
Harmonic Fluctuations	EN61000-3-3		

### EMC: Immunity

Phenomenon	Standard	Test Level	Criteria	Notes & Conditions
Low Voltage PSU EMC	EN61204-3	High severity level	as below	
Harmonic Current	EN61000-3-2	Class A		All models
		Class C		> 50 W
Radiated	EN61000-4-3	3	A	
EFT	EN61000-4-4	3	A	
Surges	EN61000-4-5	Installation class 3	A	
Conducted	EN61000-4-6	3	A	
Dips and Interruptions	EN55024 (100 VAC)	Dip >95% (0 VAC), 8.3ms	A	
		Dip 30% (70 VAC), 416ms	A	
		Dip >95% (0 VAC), 4160ms	B	
	EN55024 (240 VAC)	Dip >95% (0 VAC), 10.0ms	A	
		Dip 30% (168 VAC), 500ms	A	
		Dip >95% (0 VAC), 5000ms	B	
	EN60601-1-2 (100 VAC)	Dip >95% (0 VAC), 10.0ms	A	
		Dip >95% (0 VAC), 20.0ms	B	Derate Output Power to 70% for criteria A
		Dip 60% (40 VAC), 100ms	A	Derate Output Power to 50%
		Dip 30% (70 VAC), 500ms	A	
	EN60601-1-2 (240 VAC)	Dip >95% (0 VAC), 5000ms	B	
		Dip >95% (0 VAC), 10.0ms	A	
		Dip >95% (0 VAC), 20.0ms	B	Derate Output Power to 70% for criteria A
		Dip 60% (96 VAC), 100ms	A	
Dip 30% (168 VAC), 500ms		A		
		Dip >95% (0 VAC), 5000ms	B	

### Safety Approvals

Safety Agency	Safety Standard	Notes & Conditions
CB Report	IEC60950-1 & IEC62368-1	Information Technology
	IEC60601-1 Including Risk Management	Medical
UL	UL62368-1, CSA62368-1 via cUL	Information Technology
	ANSI/AAMI ES60601-1 & CSA C22.2, No.60601-1	Medical
TUV	EN62368-1	Information Technology
	EN60601-1	Medical
CE	LVD & RoHS	
Equipment Protection Class	Class I	See safety agency conditions of acceptability for details

Means of Protection		Category
Primary to Secondary	2 x MOPP (Means of Patient Protection)	IEC60601-1
Primary to Earth	1 x MOPP (Means of Patient Protection)	
Secondary to Earth	1 x MOPP at 48 VDC	

### Mechanical Details

#### GSP750-EF

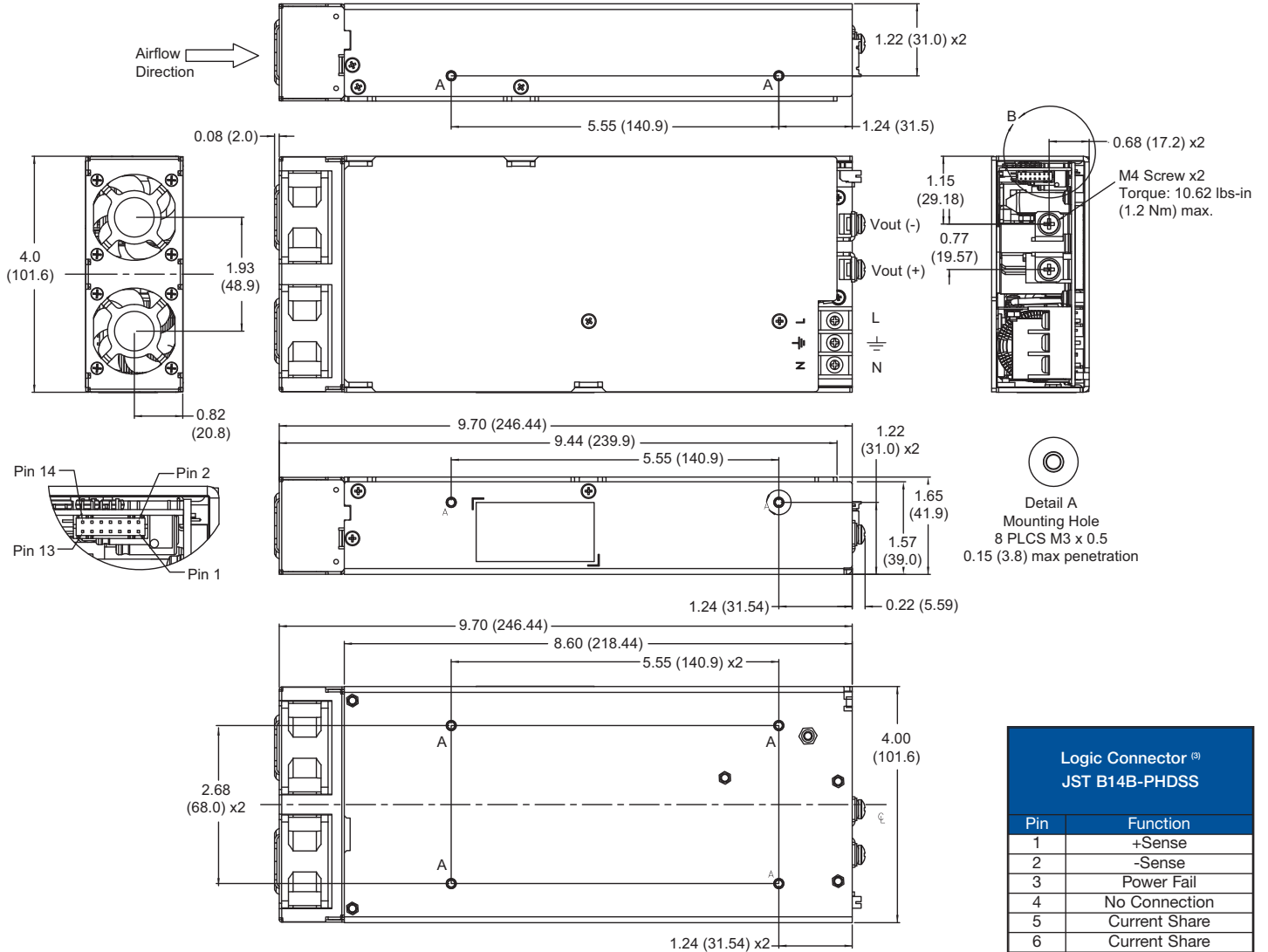

#### Notes

- All dimensions in inches (mm).
- Tolerance .xx =  $\pm 0.02$  (0.50); .xxx =  $\pm 0.01$  (0.25)
- Logic connector J301 mates with JST housing PHDR-14VS and SPHD-001T-P0.5 crimp terminals.

#### Logic Connector<sup>®</sup> JST B14B-PHDS

Pin	Function
1	+Sense
2	-Sense
3	Power Fail
4	No Connection
5	Current Share
6	Current Share
7	+Inhibit
8	-Inhibit
9	+5V Standby
10	+5V Standby
11	5V Standby Return
12	5V Standby Return
13	No Connection
14	No Connection