

# 250-450 Watts

## LP & LP-MD Series



- Configurable for Fast Time to Market
- Industrial/IT & Medical Approvals
- All Outputs Isolated
- Low Profile 1U Applications
- Wide Voltage Adjustment Range
- SEMI F47 Certified
- 3 Year Warranty

### Specification

#### Input

Input Voltage	• 90-264 VAC
Input Frequency	• 47-63 Hz
Inrush Current	• 20 A pk max, cold start 25 °C
Power Factor	• >0.9
Input Protection	• P3/M3: Internal T5 A/250 V fuse in line P4/M4: Internal T6.3 A/250 V fuse in line P5/M5: Internal T10 A/250 V fuse in line. M versions include fuse in neutral

#### Output

Output Voltage	• See module table
Output Voltage Trim	• ±10 % min all modules. See module table for extended adjustment range
Hold Up Time	• 20 ms min
Line Regulation	• Typically 0.1%, maximum 0.3%
Load Regulation	• 1% max for single output modules & V1 of dual & triple output modules 2% max for V2 & V3 of dual & triple output modules A 10% load must be applied to output 1 of the high current dual module (U) & triple module (T) to achieve this figure
Ripple & Noise	• 50 mV or 1% pk-pk, whichever is greater, 20 MHz bandwidth
Overvoltage Protection	• 120-130% Vnom for single output & output 1 of high current dual modules (U) & triple modules (T)
Overload Protection	• <160% of nominal rating
Short Circuit Protection	• Foldback
Temperature Coefficient	• 0.03%/°C
Remote Sense	• Compensates for up to 0.5 V drop on single (S) output modules & output 1 of dual (U) & triple (T) output modules
Current Share	• Single wire parallel current share. See signals & controls page

#### General

Efficiency	• 75% typical at nominal input
Isolation	• 4000 VAC Input to Output 1500 VAC Input to Ground 500 VAC Output to Ground
Signals & Controls	• AC OK, DC OK, Global & Module Inhibit See signals & controls page
MTBF	• 1,380,538 Hrs demonstrated
Switching Frequency	• 60 kHz typical PFC, 200 kHz typical modules

#### Environmental

Operating Temperature	• 0 °C to +70 °C, derate linearly from 100% at +50 °C to 50% at +70 °C for fan versions See airflow curves for U-channel versions
Storage Temperature	• -40 °C to +85 °C
Operating Altitude	• 3000 m
Shock	• 30 g, 11 ms (half sine), 3 shocks each axis, 18 shocks total. Compliant with EN60068-2-27
Vibration	• 2 g, 10-500 Hz, 10 sweeps 3 axes Compliant with EN60068-2-27

#### EMC & Safety

Emissions	• LP models P3-P5: EN55032, level B conducted LP-MD models, M3-M5: EN55011, level A conducted with FE(x) cover, M(x) level B conducted with ME(x) cover
Harmonic Currents	• EN61000-3-2, Class A
Voltage Flicker	• EN61000-3-3
ESD Immunity	• EN61000-4-2, level 3 Perf Criteria A
Radiated Immunity	• EN61000-4-3, level 3 Perf Criteria A
EFT/Burst	• EN61000-4-4, level 3 Perf Criteria A
Surge	• EN61000-4-5, installation class 3 Perf Criteria A
Conducted Immunity	• EN61000-4-6, level 3 Perf Criteria A
Dips & Interruptions	• EN61000-4-11, 30% 10 ms, 60% 100 ms, 100% 5000 ms, Criteria A, B, B
Safety Approvals	• LP models: EN62368-1, UL62368-1, CSA62368-1 via cUL, SEMI F47 compliant (highline only) LP-MD models: EN60601-1, CSA60601-1 via cUL UL60601-1

**P3 & M3 (250 W) Model**  
Module Position 2 1

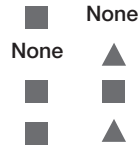

**P4 & M4 (350 W) Model**  
Module Position 2 1

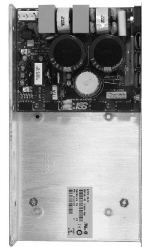

**P5 & M5 (450 W) Model**  
Module Position 2 1

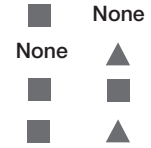
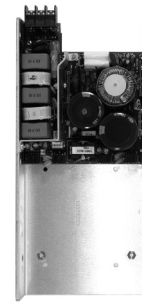

**STEP 1**

In order to configure a model number for your LP (industrial) or LP-MD (medical) series power supply, first select the appropriate chassis based on your application's continuous, maximum output power requirements. Select 'P' (e.g. P3) for industrial or 'M' (e.g. M3) for medical.

**STEP 2**

From the ratings below, select the output modules that suit your output voltage and current requirements. Modules can be positioned as denoted by the ■ and ▲ sequence shown above e.g. P3S3T1FE301. P5 and M5 models supplied with fan cover.

**STEP 3**

Form the model number as shown below, ensuring you have selected a cooling method.

**Example**

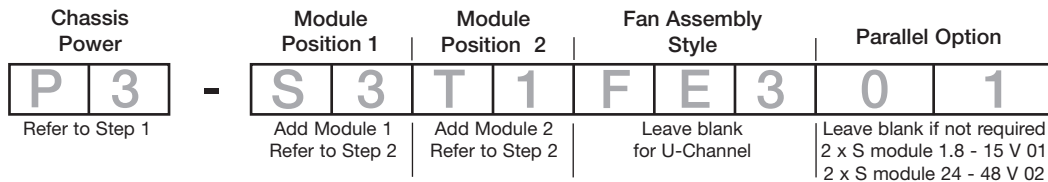

**Output Modules Voltage (Adjustment) & Current Ratings**

Output 1	Output 2	Output 3	Module Code	Model Size
1.8 V (1.65-1.95 V) @ 50 A			SZ	■
2.5 V (2.25-2.75 V) @ 50 A			S1	■
3.3 V (2.97-3.63 V) @ 50 A			S2	■
5.0 V (4.50-5.50 V) @ 50 A			S3	■
8.0 V (7.20-8.80 V) @ 31 A			SF	■
10.0 V (9.00-11.00 V) @ 25 A			SG	■
12.0 V (11.00-13.00 V) @ 20 A			S4	■
15.0 V (14.00-16.00 V) @ 17 A			S5	■
24.0 V (21.00-26.00 V) @ 10 A			S6	■
28.0 V (25.00-31.00 V) @ 9 A			S7	■
36.0 V (32.00-40.00 V) @ 7 A			S8	■
48.0 V (43.00-53.00 V) @ 5 A			S9	■
3.3 V (3.25-3.50 V) @ 40 A	5.0 V (4.8-16.0 V) @ 4.0 A		U5 <sup>(2)</sup>	■
3.3 V (3.25-3.50 V) @ 40 A	12.0 V (4.8-16.0 V) @ 4.0 A		U6 <sup>(2)</sup>	■
3.3 V (3.25-3.50 V) @ 40 A	15.0 V (4.8-16.0 V) @ 4.0 A		U7 <sup>(2)</sup>	■
3.3 V (3.25-3.50 V) @ 40 A	24.0 V (19.0-28.0 V) @ 2.5 A		U8 <sup>(2)</sup>	■
5.0 V (4.80-5.20 V) @ 40 A	5.0 V (4.8-16.0 V) @ 4.0 A		U1 <sup>(2)</sup>	■
5.0 V (4.80-5.20 V) @ 40 A	12.0 V (4.8-16.0 V) @ 4.0 A		U2 <sup>(2)</sup>	■
5.0 V (4.80-5.20 V) @ 40 A	15.0 V (4.8-16.0 V) @ 4.0 A		U3 <sup>(2)</sup>	■
5.0 V (4.80-5.20 V) @ 40 A	24.0 V (19.0-28.0 V) @ 2.5 A		U4 <sup>(2)</sup>	■
5.0 V (4.80-5.20 V) @ 8 A	12.0 V (11.5-12.5 V) @ 6.0 A		R6 <sup>(1)</sup>	▲
5.0 V (4.80-5.20 V) @ 8 A	24.0 V (22.0-26.0 V) @ 3.0 A		R4 <sup>(1)</sup>	▲
12.0 V (11.50-12.50 V) @ 6 A	12.0 V (11.5-12.5 V) @ 6.0 A		R1 <sup>(1)</sup>	▲
12.0 V (11.50-12.50 V) @ 6 A	24.0 V (22.0-26.0 V) @ 3.0 A		R5 <sup>(1)</sup>	▲
15.0 V (14.00-16.00 V) @ 5 A	15.0 V (14.0-16.0 V) @ 5.0 A		R2 <sup>(1)</sup>	▲
3.3 V (3.25-3.50 V) @ 20 A	12.0 V (4.8-16.0 V) @ 4.0 A	12.0 V (4.8-16.0 V) @ 4 A	T3 <sup>(2)</sup>	▲
3.3 V (3.25-3.50 V) @ 20 A	15.0 V (4.8-16.0 V) @ 3.0 A	15.0 V (4.8-16.0 V) @ 3 A	T4 <sup>(2)</sup>	▲
5.0 V (4.80-5.20 V) @ 20 A	12.0 V (4.8-16.0 V) @ 4.0 A	12.0 V (4.8-16.0 V) @ 4 A	T1 <sup>(2)</sup>	▲
5.0 V (4.80-5.20 V) @ 20 A	15.0 V (4.8-16.0 V) @ 3.0 A	15.0 V (4.8-16.0 V) @ 3 A	T2 <sup>(2)</sup>	▲
5.0 V (4.80-5.20 V) @ 20 A	12.0 V (4.8-16.0 V) @ 4.0 A	5.0 V (4.8-16.0 V) @ 4 A	T8 <sup>(2)</sup>	▲
12.0 V (11.50-12.50 V) @ 10 A	12.0 V (4.8-16.0 V) @ 4.0 A	5.0 V (4.8-16.0 V) @ 4 A	T6 <sup>(2)</sup>	▲
12.0 V (11.50-12.50 V) @ 10 A	12.0 V (4.8-16.0 V) @ 4.0 A	15.0 V (4.8-16.0 V) @ 3 A	T10 <sup>(2)</sup>	▲
24.0 V (22.00-26.00 V) @ 4 A	5.0 V (4.8-16.0 V) @ 4.0 A	5.0 V (4.8-16.0 V) @ 4 A	T11 <sup>(2)</sup>	▲
24.0 V (22.00-26.00 V) @ 4 A	15.0 V (4.8-16.0 V) @ 4.0 A	5.0 V (4.8-16.0 V) @ 4 A	T9 <sup>(2)</sup>	▲
24.0 V (22.00-26.00 V) @ 4 A	15.0 V (4.8-16.0 V) @ 3.0 A	15.0 V (4.8-16.0 V) @ 3 A	T7 <sup>(2)</sup>	▲

1. R modules do not have signals or control facilities.  
2. Output V2 & V3 of U & T modules can supply up to 5 A in certain applications dependent on other rail loadings. Contact sales for details.  
3. Certain model configurations are available from Farnell and Newark.

**AC OK/Power Fail**

When fitted in module position 2 of the chassis, pins 10 and 2 provide a minimum of 5 ms warning of loss of output regulation.

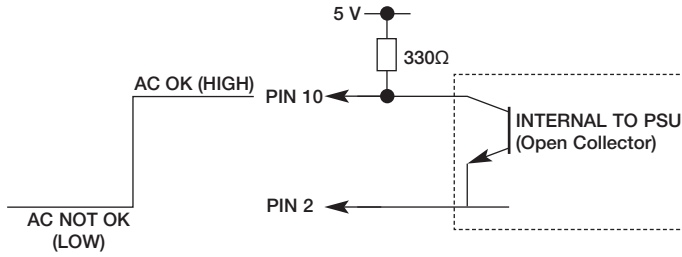

**Current Share**

Connecting pins 4 & 2 of like part number modules (3 maximum) within the same chassis or separate chassis will force the modules to current share the outputs.

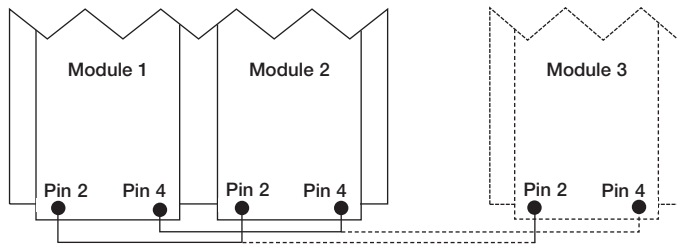

**DC OK**

Pins 8 and 2 provide notification that the output voltage is within regulation via a logic 1.

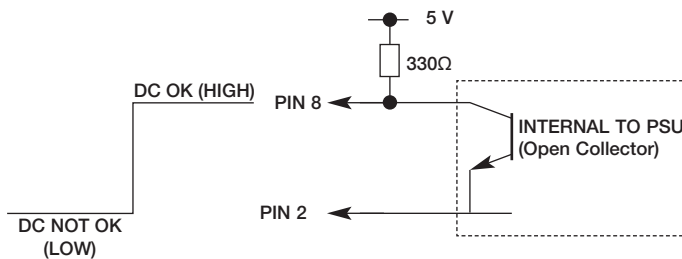

(Reverse logic option available, i.e. high for DC NOT OK).

**Notes**

1. R module does not have these signal facilities.

**Global Inhibit**

Inhibiting the module fitted in position 2 will inhibit all outputs of other modules (fans remain running if fitted). If individual inhibit is required on the module fitted in chassis position 2 alternative configurations are available. Contact sales for further information.

**Module Inhibit**

Pins 6 and 2 (return) provide on/off control of the module. Applying a logic '0' between these pins turns the module off.

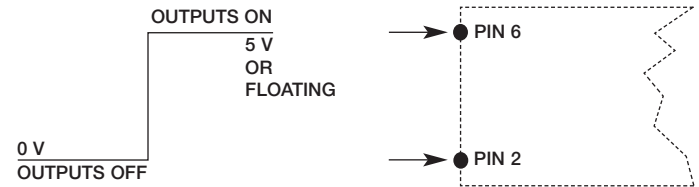

(Reverse logic option available, i.e. high for outputs off or low for outputs on).

**Modules in Parallel**

Single output modules with the same part number and V1 of dual and triple output modules can be paralleled to obtain increased output current. These modules can either be fitted in the same chassis or a different chassis with their outputs connected directly together and current share connections made, see *Current Share*.

**Modules in Series**

Single output modules can be connected in series to obtain alternate output voltages not available from a single module. For example a 10 V (SG module) can be connected in series with a 12 V (S4 module) to obtain an output voltage of 22 V. Maximum output voltage 60 VDC.

**Remote Sense**

Pins 1 +ve and 2 -ve provide compensation for voltage drops in application wiring up to a maximum of 0.5 V. Remote Sense is not fitted to R modules and V2 & V3 of U and T modules.

**Housekeeping**

A 5 V standby voltage rated at 1 A is fitted to each chassis.

## Mechanical Details

### 250 Watt P3 & M3 Models and 350 Watt P4 & M4 Models

#### U Channel

See Airflow Curves

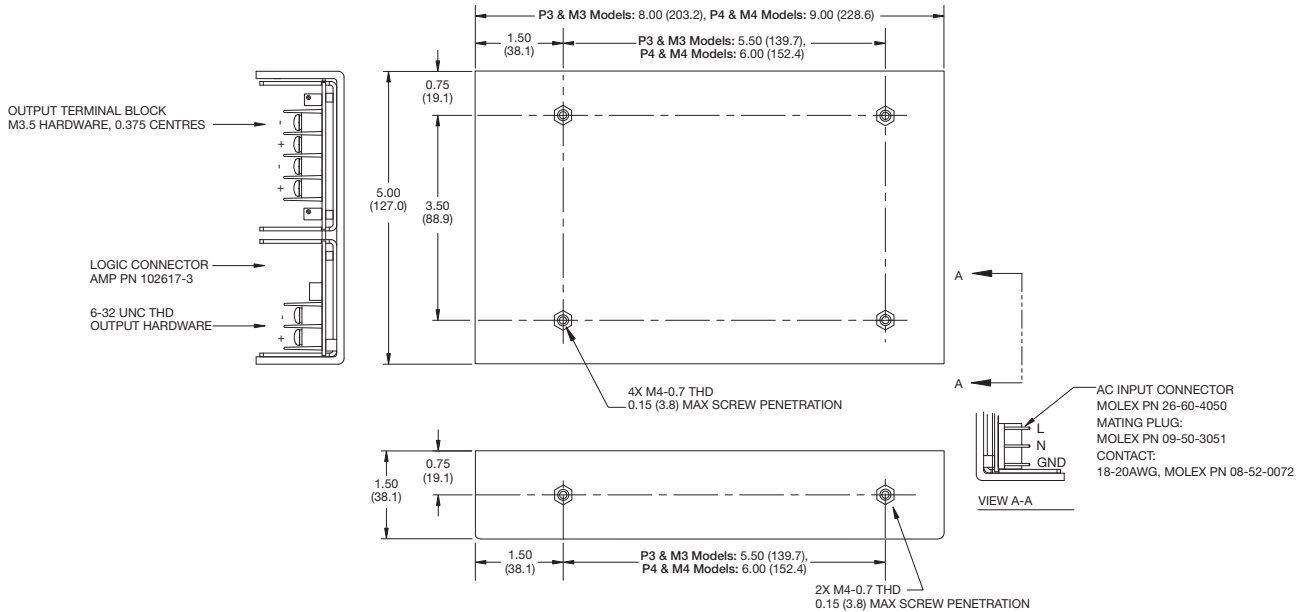

Weight: 250 Watt P3 & M3 Model: 1.40 lb (0.64 kg) approx  
350 Watt P4 & M4 Model: 1.50 lb (0.68 kg) approx

#### FE3, FE4 and FE5 Fan Assembly

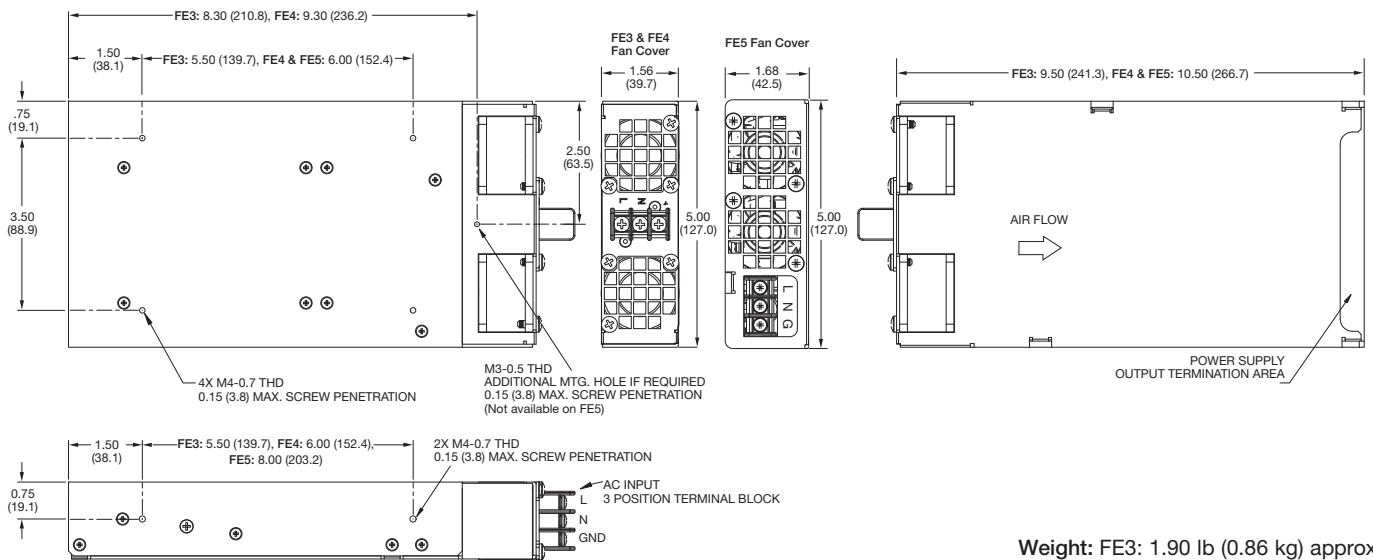

Weight: FE3: 1.90 lb (0.86 kg) approx  
FE4: 2.00 lb (0.91 kg) approx  
FE5: 2.62 lb (1.19 kg) approx

#### Notes

1. Dimensions in inches (mm). Tolerance: X.XX = ±0.02 (0.50), X.XXX = ±0.01 (0.25)
2. Supplies are SEMI F47 at highline input (180-264) at 100% rated output power. Certification details available on request.
3. Mating connector kit available. Order part number LP CONN KIT.
4. For mating connectors, use pinouts as detailed in this datasheet. May not match manufacturers mold marks on connector.
5. P5 chassis supplied with fan cover.

350 Watt ME4 Fan Assembly (M Models Only)

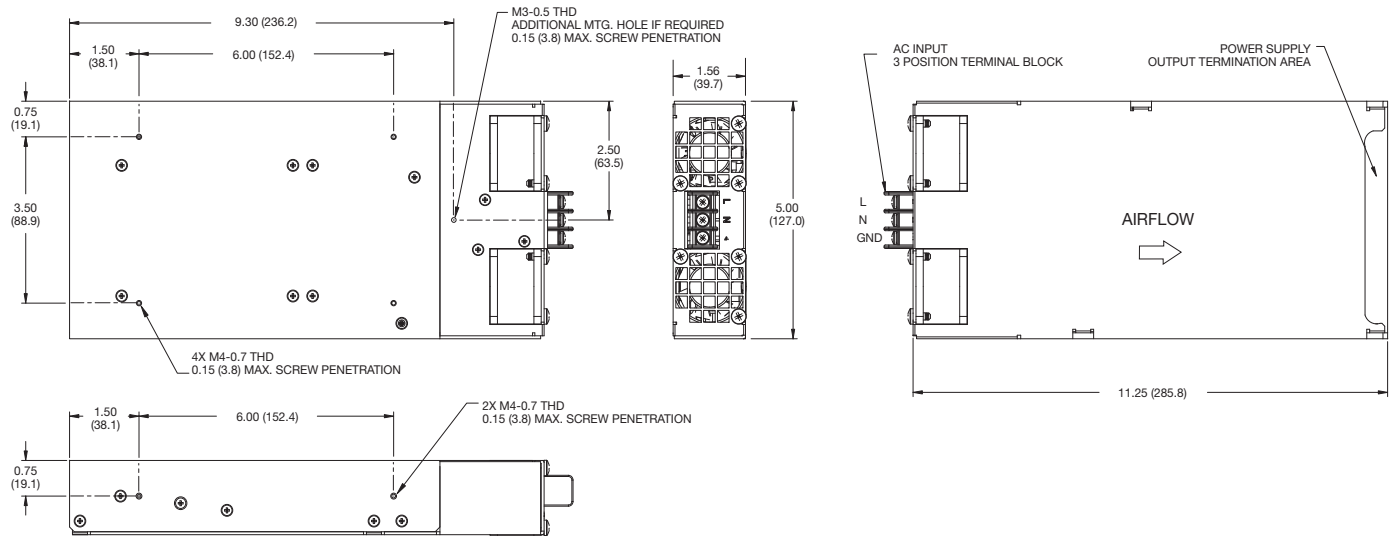

Weight: ME4: 2.16 lb (0.98 kg) approx

ME5 Fan Assembly (M Models Only)

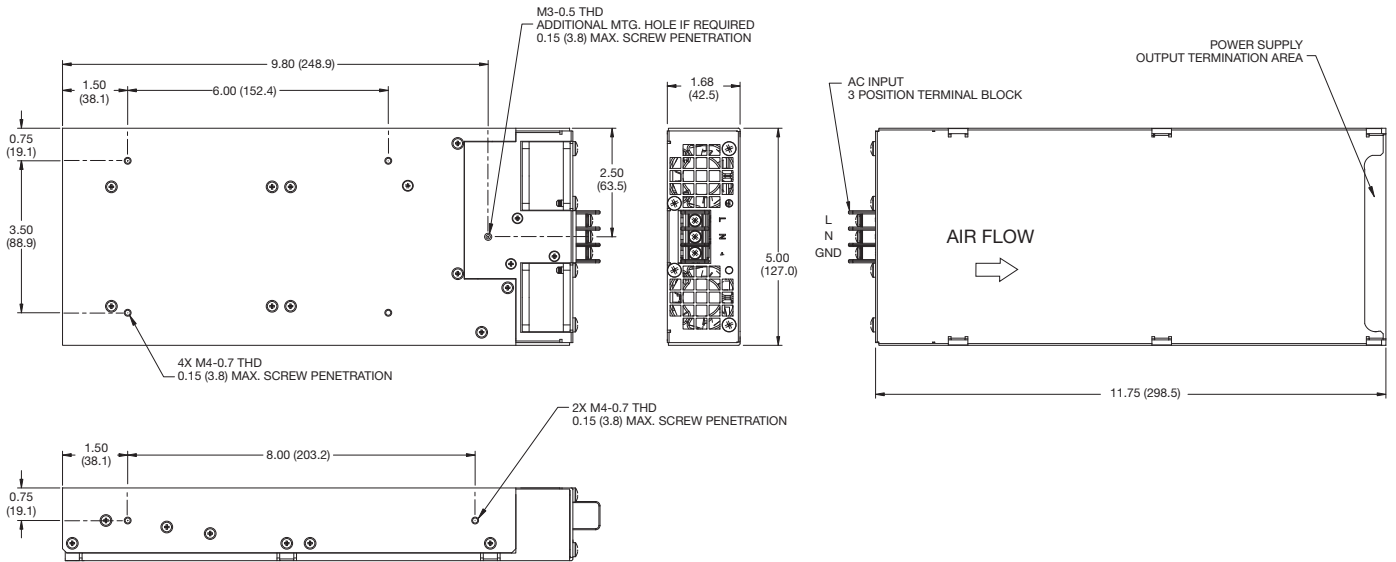

Weight: 2.62 lb (1.19 kg) approx

Notes

1. Dimensions in inches (mm). Tolerance: X.XX = ±0.02 (0.50), X.XXX = ±0.01 (0.25)
2. Supplies are SEMI F47 at highline input (180-264) at 100% rated output power. Certification details available on request.
3. Mating connector kit available. Order part number LP CONN KIT.
4. For mating connectors, use pinouts as detailed in this datasheet. May not match manufacturers mold marks on connector.
5. M5 chassis supplied with fan cover.

**Airflow Curves - U-Channel Models LP & LP-MD 250-450**

The curves denote chassis derating. Output modules must be derated by the same proportion.

Formula for converting CFM to LFM:

$$LFM = \frac{CFM \times 144}{(\text{total cross section of airflow path (Inches}^2\text{)})}$$

Formula for converting LFM to CFM:

$$CFM = \frac{LFM \times (\text{total cross section of airflow path (Inches}^2\text{)})}{144}$$

**P3 & M3 Models**

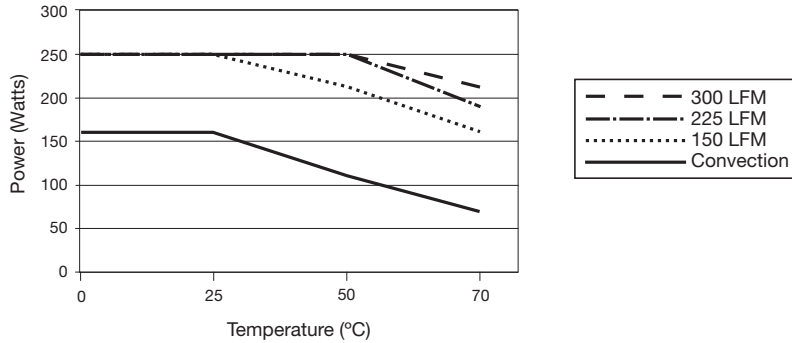

**P4 & M4 Models**

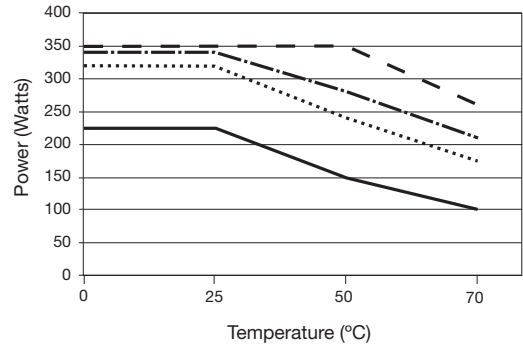

**Output Module Connection Details**

**Single Output (S)**

Weight: 0.50 lb (227 g) approx

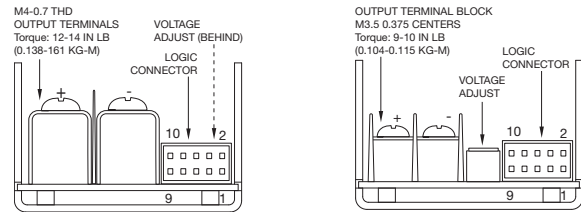

Logic Connector AMP 87631-5	
Pin	Function
1	+sense (V1)
2	-sense (V1)
3	+sense (V1)
4	Current share
5	
6	Inhibit
7	-sense (V1)
8	DC OK
9	
10	Power fail

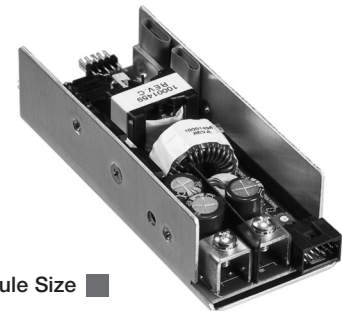

Module Size ■

For mating connectors, use pinouts as detailed in this datasheet. May not match manufacturers mold marks on connector.

**Dual Output (R)**

Weight: 0.52 lb (236 g) approx

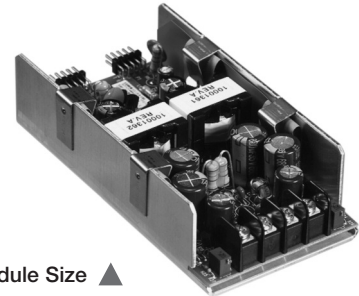
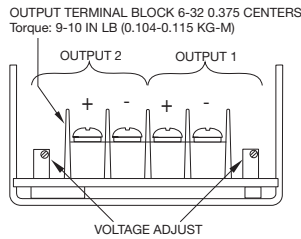

Module Size ▲

**Dual Output (U)**

Weight: 0.62 lb (282 g) approx

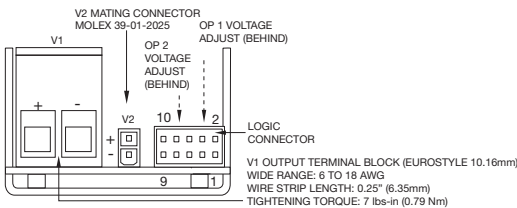

Logic Connector AMP 87631-5	
Pin	Function
1	+sense (V1)
2	-sense (V1)
3	+sense (V1)
4	Current share
5	
6	Inhibit
7	-sense (V1)
8	DC OK
9	
10	Power fail

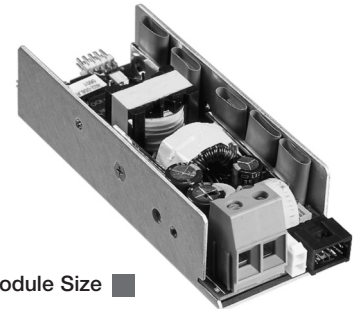

Module Size ■

For mating connectors, use pinouts as detailed in this datasheet. May not match manufacturers mold marks on connector.

**Triple Output (T)**

Weight: 0.70 lb (318 g) approx

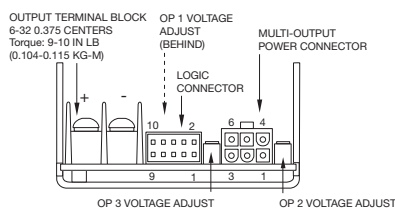

Output Connector Molex 39-01-2060	
Pin	Function
1	Output RTN V2
2	
3	Output RTN V3
4	Output 2+
5	
6	Output 3+

Logic Connector AMP 87631-5	
Pin	Function
1	+sense (V1)
2	-sense (V1)
3	+sense (V1)
4	Current share
5	
6	Inhibit
7	-sense (V1)
8	DC OK
9	
10	Power fail

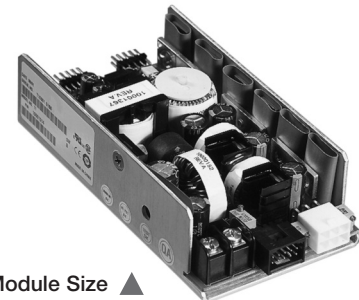

Module Size ▲

For mating connectors, use pinouts as detailed in this datasheet. May not match manufacturers mold marks on connector.