

40W

AC-DC
power supplies

40W version of low cost green power AC-DC power supplies, with approvals to world-wide safety standards including ITE and household, the VCE40 are available for PCB mounting as encapsulated or open frame (with suffix -P). Their compact design features an integral EMC filter and hold-up capacitor, so no external components are required.

The VCE40 provides a cost-effective, PCB mount, single component, AC-DC power supply solution for Internet of Things (IoT) including home automation, heating & lighting control, smart metering, set-top box & multiple industrial applications.

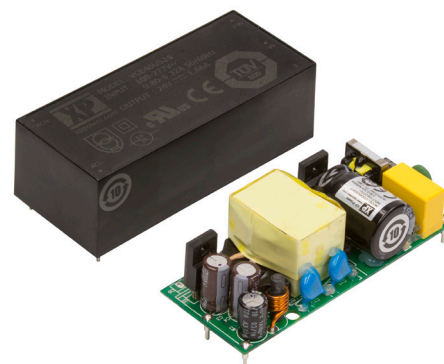

Features

- ▶ Regulated single outputs from 3.3V to 48VDC
- ▶ Wide input range 85 to 305VAC
- ▶ Encapsulated or open frame PCB mount
- ▶ ITE & household appliance approvals
- ▶ EN55035 immunity standard
- ▶ Class II operation
- ▶ No load input power <0.3W
- ▶ -25°C to +70°C operating temperature
- ▶ 3 year warranty

Applications

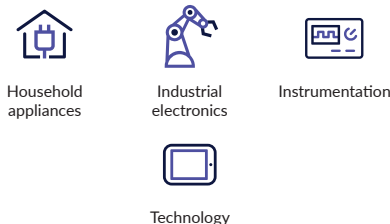

Dimensions

VCE40
87.9 x 38.1 x 28.5mm (3.46 x 1.50 x 1.12")

VCE40
85.0 x 35.1 x 27.7mm (3.35 x 1.38 x 1.09")

Models & ratings

Model number	Output voltage	Output current	Output power
VCE40US03	3.3VDC	9.10A	30W
VCE40US05	5.0VDC	8.00A	40W
VCE40US09	9.0VDC	4.44A	40W
VCE40US12	12.0VDC	3.33A	40W
VCE40US15	15.0VDC	2.66A	40W
VCE40US24	24.0VDC	1.66A	40W
VCE40US48	48.0VDC	0.82A	40W

Notes:

1. For Open Frame version add suffix -P to model number, e.g. VCE40US12-P.

Input

Characteristic	Minimum	Typical	Maximum	Units	Notes & conditions
Input voltage	85		305	VAC	Derate from 100% at 90VAC to 90% at 85VAC
Input frequency	47		63	Hz	
Input current - full load		0.7/0.4		A rms	Measured at 115/230VAC
No load input power			0.3	W	
Inrush current			40	A	Measured at 230VAC, cold start at 25°C
Earth leakage current	Class II construction no earth				
Input protection	Internal T1.0 A/300 VAC fuse fitted in line				

Output

Characteristic	Minimum	Typical	Maximum	Units	Notes & conditions
Output voltage	3.3		48	VDC	
Initial set accuracy			1.5/1.0	%	1.5% for 3V3 & 5V models, 1% for others at 50% load
Minimum load	0			A	No minimum load required
Line regulation			1	%	
Load regulation			2	%	
Start up delay			2	s	
Start up rise time			35	ms	
Hold up time	8	14		ms	At full load and 115VAC
Transient response			4	%	Deviation, recovery within 1% in less than 500µs for a 25% load change
Ripple & noise			100	mV pk-pk	3V3 & 5V models, 20MHz bandwidth
			1	% pk-pk	9 to 48V models, 20MHz bandwidth
Overvoltage protection	115		140	% Vnom	210% typical for 3V3 model, auto recovery
Overload protection	110		190	%	
Short circuit protection					Trip & Restart (hiccup mode)
Temperature coefficient			0.05	%/°C	

General

Characteristic	Minimum	Typical	Maximum	Units	Notes & conditions
Efficiency		85		%	Model Dependant
Isolation: Input to Output	3000			VAC	
Switching Frequency	5		65	kHz	Varied with load
Power Density			7.7	W/in ³	For '-P' version
Mean Time Between Failure	550	600		kHrs	MIL-HDBK-217F, +25°C GB
Weight		0.187 (85)		lb (g)	Open frame versions (-P)
		0.419 (190)		lb (g)	Encapsulated version

Environmental

Characteristic	Minimum	Typical	Maximum	Units	Notes & conditions
Operating temperature	-25		+70	°C	3V3 & 5V models: derate output linearly from 100% at +45°C to 45% at +70°C. Other models: derate output linearly from 100% at 50°C to 50% at 70°C.
Storage temperature	-40		+85	°C	
Cooling	Convection-cooled				
Humidity			95	%RH	Non-condensing
Operating humidity			5000	m	
Shock	IEC68-2-27, 30g, 11 ms half sine, 3 times in each of 6 axes				
Vibration	IEC68-2-6, 2g, 10Hz to 500kHz, 10mins/cycle, 60mins each cycle				

EMC: Emissions

Phenomenon	Standard	Test Level	Notes & conditions
Conducted	EN55032	Class B	
Radiated	EN55032	Class B	
Harmonic currents	EN61000-3-2	Class A	
Voltage flicker	EN61000-3-3		

EMC: Immunity

Phenomenon	Standard	Test Level	Criteria	Notes & conditions
ITE	EN55035	As below	As Below	
ESD immunity	EN61000-4-2	±6kV contact, ±8kV air discharge	A	
Radiated immunity	EN61000-4-3	10 V/m	A	
EFT/burst	EN61000-4-4	3	A	
Surge	EN61000-4-5	2	A	Line to Line
Conducted	EN61000-4-6	10 Vrms	A	
Magnetic fields	EN61000-4-8	30 A/m	A	
Dips and interruptions	EN61000-4-11 (115 VAC)	70% UT (80.5 VAC) for 100ms	A	
		40% UT (46 VAC) for 200ms	B	
		<5% UT (0 VAC) for 10ms	A	
		<5% UT (0 VAC) for 5000ms	B	
	EN61000-4-11 (230 VAC)	70% UT (161 VAC) for 100ms	A	
		40% UT (92 VAC) for 200ms	A	
		<5% UT (0 VAC) for 10ms	A	
		<5% UT (0 VAC) for 5000ms	B	

Safety approvals

Certification	Standard	Notes & conditions
CB	IEC60950-1	ITE
	IEC62368-1	
	IEC60335-1	Household
UL	UL62368-1	ITE
TUV	EN62368-1	ITE
CE	Meets all applicable directives	
UKCA	Meets all applicable legislation	

Efficiency graphs

VCE40US12-P

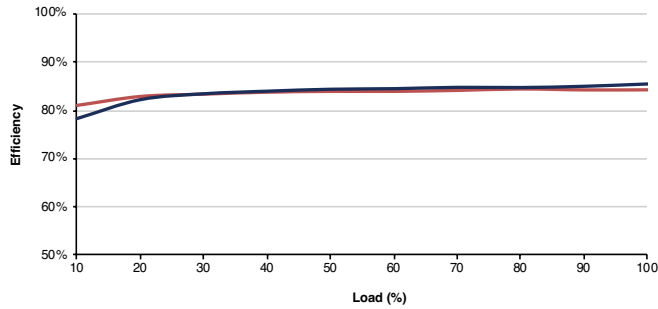

VCE40US24-P

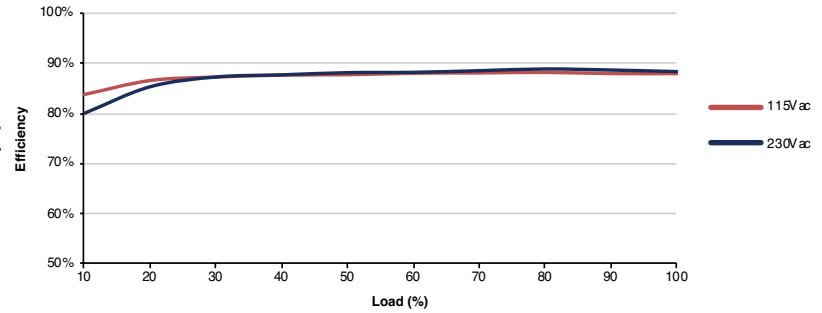

Mechanical details

Encapsulated

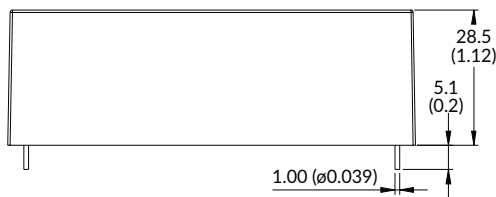
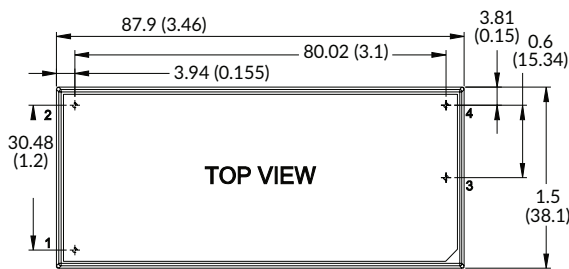

Open Frame (-P)

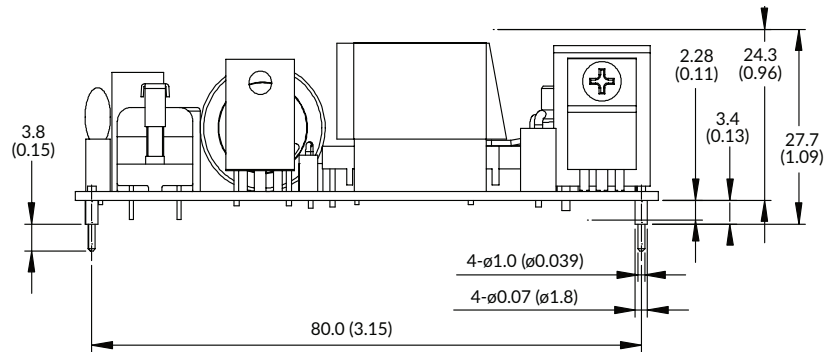
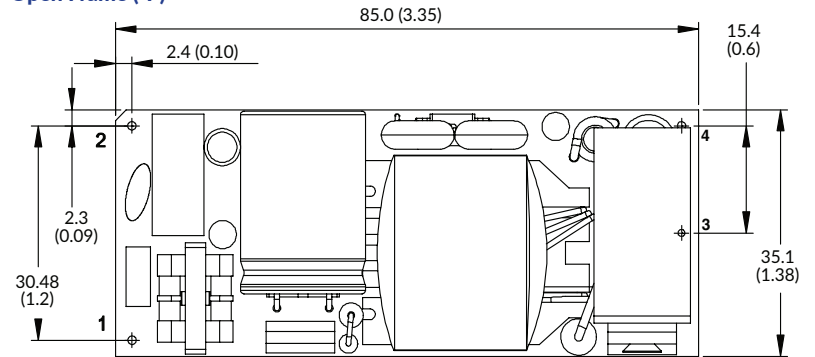

Notes:

- Dimensions in mm (inches).
- Weight: Open frame versions (-P): 85g (0.187lbs), Encapsulated: 190g (0.419lbs)
- Tolerances: x.xx = ± 0.02 (x.x = ± 0.5), x.xxx = ± 0.25 (x.xxx = ± 0.01)

Pin	Standard
1	ACL
2	ACN
3	-Vout
4	+Vout

Specifications subject to change without notice.